

TOWN OF DURHAM STORMWATER MANAGEMENT PLAN

REVISED: JANUARY 2021

**TOOMERFS, LLC
19 MAIN STREET and 21 MAIN STREET
TAX MAP 5, LOTS 1-9, 1-10, 1-15, and 1-16
Durham, New Hampshire**

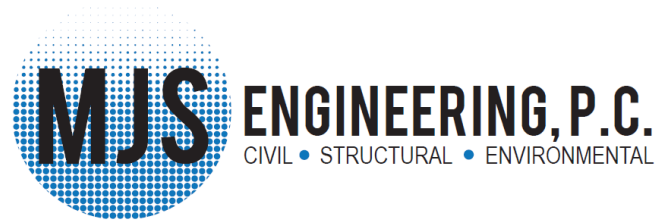
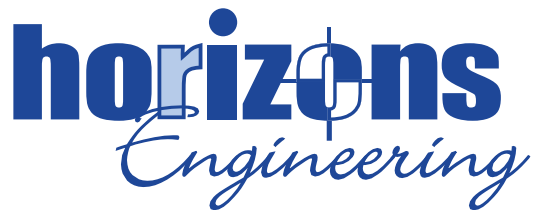

176 Newport Road – Suite 8, New London, NH 03257
Ph 603-877-0116 • Fax 603-526-4285
www.horizonsengineering.com

5 Railroad Street • P.O. Box 359, Newmarket, NH 03857
Newmarket, NH 03857 • Email: mjs@mjs-engineering.com

**TOWN OF DURHAM
STORMWATER MANAGEMENT PLAN
FOR
TOOMERFS, LLC**

**19 MAIN STREET and 21 MAIN STREET
TAX MAP 5, LOTS 1-9, 1-10, 1-15 and 1-16**

DURHAM, NEW HAMPSHIRE

**OCTOBER 2020
REVISED JANUARY 2021**

**Project Number 20601
Copyright © 2021
Horizons Engineering, Inc.**

Horizons Engineering, Inc.

New London, NH • Newport, VT • Littleton, NH • Pomfret, VT • Kennebunk, ME • Conway, NH

TABLE OF CONTENTS

1.0 PROJECT INFORMATION NARRATIVE (bound report)

1.1 Project Narrative

1.1.1 Project Summary

1.1.2 Existing Conditions

1.1.3 Proposed Site Conditions & Disturbances

1.1.4 Rainfall Data

1.1.5 Peak Runoff Control Requirement

1.1.6 Channel Protection Requirement

1.1.7 Infiltration Volume Requirement

1.2 NRCS Soils Information

(Web Soil Survey Map)

1.3 Extreme Precipitation Tables (Northeast Regional Climate Center)

2.0 DRAINAGE CALCULATIONS, ANALYSIS & DESIGN

2.1 Infiltration Volume Calculations

2.2 BMP Worksheets for all Treatment Systems

2.3 Pre-development Analysis

2.3.1 Diagram, Area Listing, Soil Listing

2.3.1 Node listing for the 2, 10, 25, 50, and 100 year storm events

2.3.2 Full summary for the 10 year storm event

2.4 Post-development Analysis

2.4.1 Diagram, Area Listing, Soil Listing

2.4.1 Node listing for the 2, 10, 25, 50, and 100 year storm events

2.4.2 Full summary for the 10 year storm event

2.5 Stone Riprap Calculations (Energy Dissipation – Stability Calculations)

2.6 Site Specific Soil Survey

2.7 Inspection and Maintenance Manual

2.8 References – Preparer's/Reviewer's Certification

3.0 PLANS

3.1 Design Plans (unbound)

3.2 Wetlands Plan

3.3 Color Coded Hydrologic Soil Group Plans

3.4 Pre and Post Development Drainage Area Plans

LIST OF TABLES

Table 1.0 – 1 Inch; 2, 10, 25, 50, and 100 Year Comparison

Table 1.1 – Proposed Disturbance Area Breakdown

Table 1.2 - Type II, 24 Hour Rainfall Depths for Project Site (43.133°N, 70.923°W)

Table 1.3 – Reprint of Table 1.0 – 1 Inch; 2, 10, 25, 50, and 100 Year Comparison

Table 1.4 – 1 Inch; 2, 10, 25, 50, and 100 Year Volume Comparison

SECTION 1.0 PROJECT INFORMATION NARRATIVE

1.1 Project Narrative

1.2.1 Project Summary

Toomerfs, LLC intends to develop a parking facility at 19 and 21 Main Street, in Durham, New Hampshire, on Tax Map 5, Lots 1-9, 1-10, 1-15, and 1-16. The parking facility will serve the apartments at the front of the site, as well as providing needed extra parking capacity for off-site student housing in town. Additionally, the driveway to the site will be reconstructed to improve clearances to the existing buildings.

The parking area will be constructed on a filled pad, supported by an engineered pre-cast retaining wall on the south end of the site. Fill and grading for subgrade preparation will be required to complete the pad improvements. The total disturbance for this work is 79,700 square feet. Stormwater from the parking area will be directed via sheet flow to swales leading to catchbasins feeding an underground ADS Stormtech MC4500 chamber system within the fill area. The chambers will allow infiltration into the fill area and to native ground. An overflow structure is provided to control flowrates for larger storm events.

The following table shows the 1-inch storm; 2, 10 and 25 year peak flow rate comparison at the discharge points.

Table 1.0 – 1 Inch; 2, 10 and 25 Year Comparison

Watershed Area Discharge Point	Pre 1 In Flow Rate (cfs)	Post 1 In Flow Rate (cfs)	Pre 2 Yr Flow Rate (cfs)	Post 2 Yr Flow Rate (cfs)	Pre 10 Yr Flow Rate (cfs)	Post 10 Yr Flow Rate (cfs)	Pre 25 Yr Flow Rate (cfs)	Post 25 Yr Flow Rate (cfs)
DP-1	0.00	0.00	2.17	2.14	5.29	5.28	8.03	7.59
DP-2	0.13	0.08	0.66	0.55	1.07	0.93	1.38	1.22

Impacts to watershed water quality from grading within the watersheds would be likely to occur from uncontrolled discharge of site runoff during construction activities and stabilized post-project surfaces. To minimize the impacts to the watersheds, the site has been designed to cause no increase in runoff and erosion control methods have been sized in accordance with the Env-Wq 1500 and the *New Hampshire Stormwater Management Manual* (December, 2008).

1.2.2 Existing Site Conditions

The proposed work is located on the south side of Main Street approximately 0.10 miles east of the intersection of Newmarket Road. The primary project site is located behind existing residential apartments.

The project site currently consists of forest sloping to the south down to College Brook. The upper portion of the site includes three residences, a garage, and an existing 26-space paved parking lot.

There are existing no delineated wetlands located with the project disturbance area, and no wetland impacts are proposed as part of this project. Wetland exists in the extreme south of the property, however buffer areas are to be maintained to these wetlands.

1.1.3 Proposed Site Conditions & Disturbances

The project proposes the removal of an existing structure, reconstruction of the site’s driveway, and construction of a 153-space parking lot. To create the relatively level area required for the parking lot, an engineered concrete block retaining wall will be constructed, and significant quantities of engineered fill will be imported to the site. An underground chamber system is proposed to detain and infiltrate stormwater from the site. In the immediate vicinity of the chamber system, the imported fill will be design to produce a hydraulic conductivity matching the underlying soils.

Approximately 79,700 square feet of earth disturbance will be required to construct the driveway improvements and parking lot, and associated utilities and drainage practices. An area of disturbance breakdown has been shown in **Table 1.1**.

Table 1.1 – Proposed Disturbance Area Breakdown

Construction/Disturbance Activity	Area (square feet)	% EIC*	% UDC*
Grading and Site Disturbance	79,700	-	-
Total Impervious Area (within drainage area)	73,282	56.6%	
Total Undisturbed Area (within drainage area)	28,991		22.4%
Total Drainage Area ¹	129,549		

* EIC = Effective Impervious Cover

* UDC = Undisturbed Cover

The total connected Effective Impervious Cover is 56.6% of the proposed disturbance area, and the total undisturbed area is 22.4% within the entire modeled drainage area.

The impacts to water quality during site development will be minimized using erosion control measures. Frequent site inspections during construction are required during or directly following rainfall events to ensure erosion control devices are working properly. A copy of the Stormwater Inspection and Maintenance Manual can be found in **Section 2.8** of this report.

1.1.4 Rainfall Data

Using SCS TR-20, run under HydroCAD Version 10.0 with Type III-24 hour rainfall events, pre- and post-development cover types and drainage paths were modeled to generate peak discharge rates. Rainfall events modeled have intensities described by data provided by the Northeast Regional Climate Center for the geographic location of the project. These data are provided in full in section 2.13 of this report, and are summarized below in **Table 1.2**.

Table 1.2 - Type II, 24 Hour Rainfall Depths for Project Site (43.133°N, 70.923°W)

Rainfall Event	Depth*
1-Inch	1.00"
2-Year	3.14"
10-Year	4.76"
25-Year	6.03"
50-Year	7.22"
100-Year	8.64"

* Rainfall depths from the Northeast Regional Climate Center Extreme Precipitation Tables, <http://precip.eas.cornell.edu>, accessed 20 October 2020, See section 2.13

1.1.5 Peak Runoff Control Requirement

Town of Durham Site Design Standards require that measures be taken to control the post-development peak rate runoff so that it does not exceed pre-development runoff for the 2-year, 10-year, and 17-year*, 24-hour storm events. Due to the post-project grading of the site and changes in land cover, stormwater devices were used to attenuate flow in order to meet these Peak Runoff Control requirements. **Table 1.3** summarizes the stormwater runoff peak flow rate for the 1 inch, 2, 10 and 25 year storm events. Additionally, for reference we are providing a comparison of the 50 and 100 year storm events in the table.

*Understood to be a typo, and the 25-year event is intended.

Table 1.3 – Reprint of Table 1.0 – 1 Inch; 2, 10, 25, 50, and 100 Year Comparison

Watershed Area Discharge Point	Pre 1 In Flow Rate (cfs)	Post 1 In Flow Rate (cfs)	Pre 2 Yr Flow Rate (cfs)	Post 2 Yr Flow Rate (cfs)	Pre 10 Yr Flow Rate (cfs)	Post 10 Yr Flow Rate (cfs)	Pre 25 Yr Flow Rate (cfs)	Post 25 Yr Flow Rate (cfs)	Pre 50 Yr Flow Rate (cfs)	Post 50 Yr Flow Rate (cfs)	Pre 100 Yr Flow Rate (cfs)	Post 100 Yr Flow Rate (cfs)
DP-1	0.00	0.00	2.17	1.99	5.29	5.14	8.03	7.16	10.72	8.98	14.01	13.70
DP-2	0.13	0.10	0.66	0.56	1.07	0.92	1.38	1.19	1.68	1.45	2.03	1.76

1.1.6 Runoff Volume Requirement

Town of Durham Site Design Standards require that measures be taken to control the post-development peak rate runoff so that it does not exceed pre-development runoff for the 2-year, 10-year, and 17-year*, 24-hour storm events. Additionally, shown in the table for reference, are the 50 and 100 year storm events. Receiving waters and downstream wetland channels must be protected from erosion and sedimentation resulting from the project development. **Table 1.1** summarizes the flow volume data. While runoff volumes for larger events increase at Dp-1, overall volumes are reduced.

**Understood to be a typo, and the 25-year event is intended.*

Table 1.4 – 1 Inch; 2, 10, 25, 50, and 100 Year Volume Comparison

Watershed Area Discharge Point	Pre 1 In Volume (af)	Post 1 In Volume (af)	Pre 2 Yr Volume (af)	Post 2 Yr Volume (af)	Pre 10 Yr Volume (af)	Post 10 Yr Volume (af)	Pre 25 Yr Volume (af)	Post 25 Yr Volume (af)	Pre 50 Yr Volume (af)	Post 50 Yr Volume (af)	Pre 100 Yr Volume (af)	Post 100 Yr Volume (af)
DP-1	0.003	0.000	0.201	0.196	0.454	0.492	0.680	0.747	0.906	0.994	1.186	1.296
DP-2	0.009	0.007	0.050	0.042	0.082	0.070	0.109	0.093	0.133	0.114	0.162	0.140

1.1.7 Infiltration Volume Requirement

Town of Durham Site Design Standards require that a portion of the stormwater runoff be infiltrated to protect groundwater resources. The amount of groundwater recharge required per soil group, as a ratio of the Water Quality Volume is summarized in **Table 1.4**. To provide stormwater management an infiltrating underground chamber system is proposed, providing 5,301 cubic feet of storage, equivalent to the full water quality volume for the area draining to the structure, for groundwater recharge through infiltration.

Table 1.5 – Groundwater Recharge Volume Comparison

HSG	Net Impervious Area (Acres)	Ratio of Water Quality Volume
A	0.000	1.00
B	0.387	0.75
C	0.677	0.40
D	0.005	0.16
Weighted average, full site		0.53
Required Recharge		3,141 cf
Provided Recharge		5,301 cf

1.2 NRCS Soils Information (Web Soils Survey Map)



United States
Department of
Agriculture

NRCS

Natural
Resources
Conservation
Service

A product of the National
Cooperative Soil Survey,
a joint effort of the United
States Department of
Agriculture and other
Federal agencies, State
agencies including the
Agricultural Experiment
Stations, and local
participants

Custom Soil Resource Report for Strafford County, New Hampshire

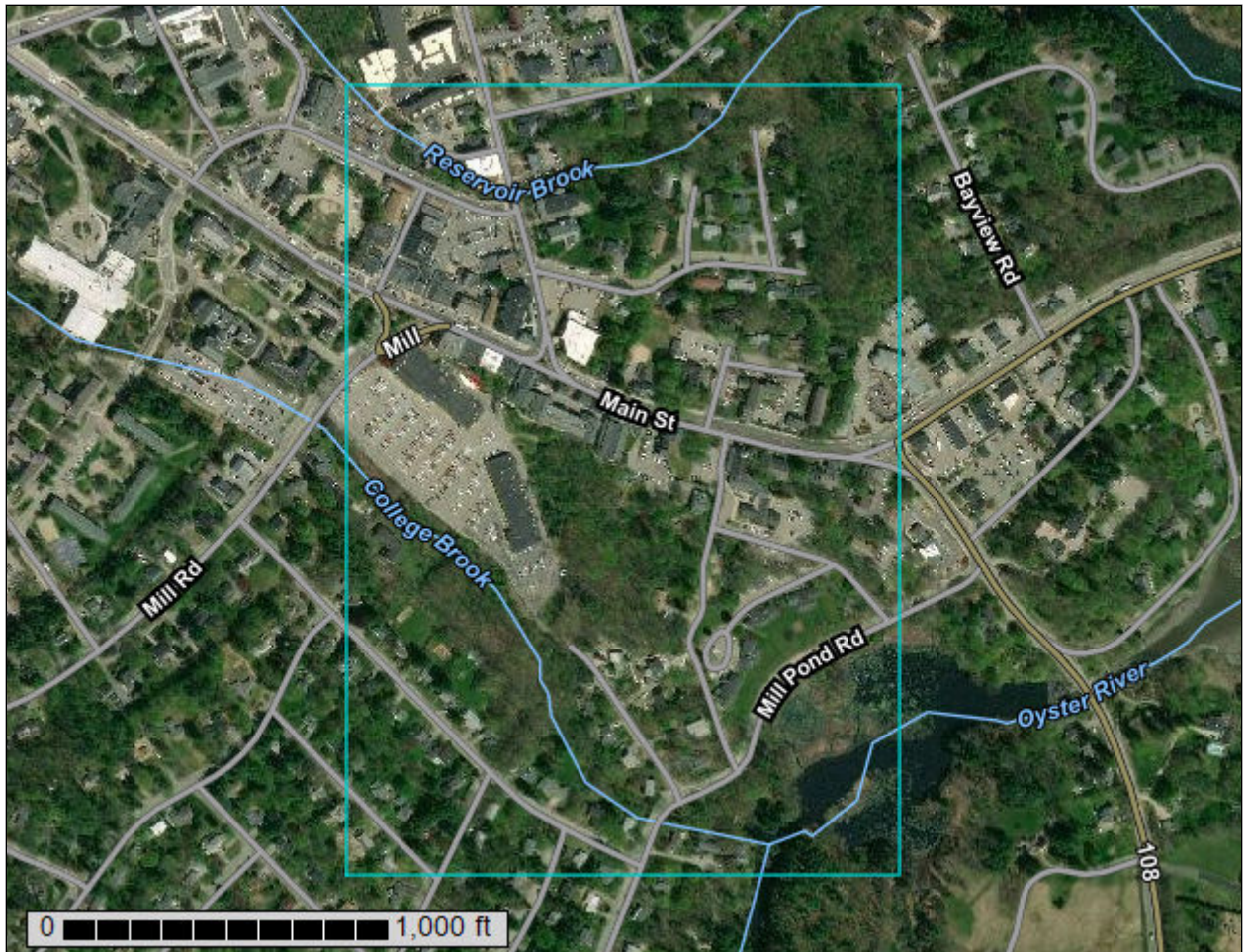

Preface

Soil surveys contain information that affects land use planning in survey areas. They highlight soil limitations that affect various land uses and provide information about the properties of the soils in the survey areas. Soil surveys are designed for many different users, including farmers, ranchers, foresters, agronomists, urban planners, community officials, engineers, developers, builders, and home buyers. Also, conservationists, teachers, students, and specialists in recreation, waste disposal, and pollution control can use the surveys to help them understand, protect, or enhance the environment.

Various land use regulations of Federal, State, and local governments may impose special restrictions on land use or land treatment. Soil surveys identify soil properties that are used in making various land use or land treatment decisions. The information is intended to help the land users identify and reduce the effects of soil limitations on various land uses. The landowner or user is responsible for identifying and complying with existing laws and regulations.

Although soil survey information can be used for general farm, local, and wider area planning, onsite investigation is needed to supplement this information in some cases. Examples include soil quality assessments (<http://www.nrcs.usda.gov/wps/portal/nrcs/main/soils/health/>) and certain conservation and engineering applications. For more detailed information, contact your local USDA Service Center (<https://offices.sc.egov.usda.gov/locator/app?agency=nrcs>) or your NRCS State Soil Scientist (http://www.nrcs.usda.gov/wps/portal/nrcs/detail/soils/contactus/?cid=nrcs142p2_053951).

Great differences in soil properties can occur within short distances. Some soils are seasonally wet or subject to flooding. Some are too unstable to be used as a foundation for buildings or roads. Clayey or wet soils are poorly suited to use as septic tank absorption fields. A high water table makes a soil poorly suited to basements or underground installations.

The National Cooperative Soil Survey is a joint effort of the United States Department of Agriculture and other Federal agencies, State agencies including the Agricultural Experiment Stations, and local agencies. The Natural Resources Conservation Service (NRCS) has leadership for the Federal part of the National Cooperative Soil Survey.

Information about soils is updated periodically. Updated information is available through the NRCS Web Soil Survey, the site for official soil survey information.

The U.S. Department of Agriculture (USDA) prohibits discrimination in all its programs and activities on the basis of race, color, national origin, age, disability, and where applicable, sex, marital status, familial status, parental status, religion, sexual orientation, genetic information, political beliefs, reprisal, or because all or a part of an individual's income is derived from any public assistance program. (Not all prohibited bases apply to all programs.) Persons with disabilities who require

alternative means for communication of program information (Braille, large print, audiotape, etc.) should contact USDA's TARGET Center at (202) 720-2600 (voice and TDD). To file a complaint of discrimination, write to USDA, Director, Office of Civil Rights, 1400 Independence Avenue, S.W., Washington, D.C. 20250-9410 or call (800) 795-3272 (voice) or (202) 720-6382 (TDD). USDA is an equal opportunity provider and employer.

Contents

Preface	2
Soil Map	5
Soil Map.....	6
Legend.....	7
Map Unit Legend.....	8
Map Unit Descriptions.....	8
Strafford County, New Hampshire.....	11
BzB—Buxton silt loam, 3 to 8 percent slopes.....	11
CsC—Charlton fine sandy loam, 8 to 15 percent slopes, very stony.....	12
HcB—Hollis-Charlton fine sandy loams, 3 to 8 percent slopes.....	13
HcC—Hollis-Charlton fine sandy loams, 8 to 15 percent slopes.....	15
HdB—Hollis-Charlton very rocky fine sandy loams, 3 to 8 percent slopes.....	17
HdC—Hollis-Charlton very rocky fine sandy loams, 8 to 15 percent slopes.....	19
HeD—Hollis-Charlton extremely rocky fine sandy loams, 8 to 25 percent slopes.....	21
Sb—Saugatuck loamy sand.....	23
SfC—Suffield silt loam, 8 to 15 percent slopes.....	24
W—Water.....	25
WfB—Windsor loamy fine sand, clay subsoil variant, 0 to 8 percent slopes.....	25
Soil Information for All Uses	27
Soil Properties and Qualities.....	27
Soil Qualities and Features.....	27
Hydrologic Soil Group.....	27
References	32

Soil Map

The soil map section includes the soil map for the defined area of interest, a list of soil map units on the map and extent of each map unit, and cartographic symbols displayed on the map. Also presented are various metadata about data used to produce the map, and a description of each soil map unit.

Custom Soil Resource Report Soil Map



Map Scale: 1:4,340 if printed on A portrait (8.5" x 11") sheet.

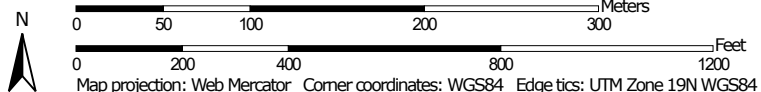

Map projection: Web Mercator Corner coordinates: WGS84 Edge tics: UTM Zone 19N WGS84

MAP LEGEND

Area of Interest (AOI)

 Area of Interest (AOI)

Soils

 Soil Map Unit Polygons

 Soil Map Unit Lines

 Soil Map Unit Points

Special Point Features

 Blowout

 Borrow Pit

 Clay Spot

 Closed Depression

 Gravel Pit

 Gravelly Spot

 Landfill

 Lava Flow

 Marsh or swamp

 Mine or Quarry

 Miscellaneous Water

 Perennial Water

 Rock Outcrop

 Saline Spot

 Sandy Spot

 Severely Eroded Spot

 Sinkhole

 Slide or Slip

 Sodic Spot

 Spoil Area

 Stony Spot

 Very Stony Spot

 Wet Spot

 Other

 Special Line Features

Water Features

 Streams and Canals

Transportation

 Rails

 Interstate Highways

 US Routes

 Major Roads

 Local Roads

Background

 Aerial Photography

MAP INFORMATION

The soil surveys that comprise your AOI were mapped at 1:20,000.

Warning: Soil Map may not be valid at this scale.

Enlargement of maps beyond the scale of mapping can cause misunderstanding of the detail of mapping and accuracy of soil line placement. The maps do not show the small areas of contrasting soils that could have been shown at a more detailed scale.

Please rely on the bar scale on each map sheet for map measurements.

Source of Map: Natural Resources Conservation Service
 Web Soil Survey URL:
 Coordinate System: Web Mercator (EPSG:3857)

Maps from the Web Soil Survey are based on the Web Mercator projection, which preserves direction and shape but distorts distance and area. A projection that preserves area, such as the Albers equal-area conic projection, should be used if more accurate calculations of distance or area are required.

This product is generated from the USDA-NRCS certified data as of the version date(s) listed below.

Soil Survey Area: Strafford County, New Hampshire
 Survey Area Data: Version 20, May 29, 2020

Soil map units are labeled (as space allows) for map scales 1:50,000 or larger.

Date(s) aerial images were photographed: Dec 31, 2009—Sep 9, 2017

The orthophoto or other base map on which the soil lines were compiled and digitized probably differs from the background imagery displayed on these maps. As a result, some minor shifting of map unit boundaries may be evident.

Map Unit Legend

Map Unit Symbol	Map Unit Name	Acres in AOI	Percent of AOI
BzB	Buxton silt loam, 3 to 8 percent slopes	31.7	33.2%
CsC	Charlton fine sandy loam, 8 to 15 percent slopes, very stony	0.8	0.9%
HcB	Hollis-Charlton fine sandy loams, 3 to 8 percent slopes	10.0	10.5%
HcC	Hollis-Charlton fine sandy loams, 8 to 15 percent slopes	3.0	3.1%
HdB	Hollis-Charlton very rocky fine sandy loams, 3 to 8 percent slopes	8.2	8.5%
HdC	Hollis-Charlton very rocky fine sandy loams, 8 to 15 percent slopes	0.0	0.0%
HeD	Hollis-Charlton extremely rocky fine sandy loams, 8 to 25 percent slopes	7.5	7.8%
Sb	Saugatuck loamy sand	0.7	0.7%
SfC	Suffield silt loam, 8 to 15 percent slopes	26.9	28.1%
W	Water	4.1	4.3%
WfB	Windsor loamy fine sand, clay subsoil variant, 0 to 8 percent slopes	2.7	2.8%
Totals for Area of Interest		95.6	100.0%

Map Unit Descriptions

The map units delineated on the detailed soil maps in a soil survey represent the soils or miscellaneous areas in the survey area. The map unit descriptions, along with the maps, can be used to determine the composition and properties of a unit.

A map unit delineation on a soil map represents an area dominated by one or more major kinds of soil or miscellaneous areas. A map unit is identified and named according to the taxonomic classification of the dominant soils. Within a taxonomic class there are precisely defined limits for the properties of the soils. On the landscape, however, the soils are natural phenomena, and they have the characteristic variability of all natural phenomena. Thus, the range of some observed properties may extend beyond the limits defined for a taxonomic class. Areas of soils of a single taxonomic class rarely, if ever, can be mapped without including areas of other taxonomic classes. Consequently, every map unit is made up of the soils or miscellaneous areas for which it is named and some minor components that belong to taxonomic classes other than those of the major soils.

Custom Soil Resource Report

Most minor soils have properties similar to those of the dominant soil or soils in the map unit, and thus they do not affect use and management. These are called noncontrasting, or similar, components. They may or may not be mentioned in a particular map unit description. Other minor components, however, have properties and behavioral characteristics divergent enough to affect use or to require different management. These are called contrasting, or dissimilar, components. They generally are in small areas and could not be mapped separately because of the scale used. Some small areas of strongly contrasting soils or miscellaneous areas are identified by a special symbol on the maps. If included in the database for a given area, the contrasting minor components are identified in the map unit descriptions along with some characteristics of each. A few areas of minor components may not have been observed, and consequently they are not mentioned in the descriptions, especially where the pattern was so complex that it was impractical to make enough observations to identify all the soils and miscellaneous areas on the landscape.

The presence of minor components in a map unit in no way diminishes the usefulness or accuracy of the data. The objective of mapping is not to delineate pure taxonomic classes but rather to separate the landscape into landforms or landform segments that have similar use and management requirements. The delineation of such segments on the map provides sufficient information for the development of resource plans. If intensive use of small areas is planned, however, onsite investigation is needed to define and locate the soils and miscellaneous areas.

An identifying symbol precedes the map unit name in the map unit descriptions. Each description includes general facts about the unit and gives important soil properties and qualities.

Soils that have profiles that are almost alike make up a *soil series*. Except for differences in texture of the surface layer, all the soils of a series have major horizons that are similar in composition, thickness, and arrangement.

Soils of one series can differ in texture of the surface layer, slope, stoniness, salinity, degree of erosion, and other characteristics that affect their use. On the basis of such differences, a soil series is divided into *soil phases*. Most of the areas shown on the detailed soil maps are phases of soil series. The name of a soil phase commonly indicates a feature that affects use or management. For example, Alpha silt loam, 0 to 2 percent slopes, is a phase of the Alpha series.

Some map units are made up of two or more major soils or miscellaneous areas. These map units are complexes, associations, or undifferentiated groups.

A *complex* consists of two or more soils or miscellaneous areas in such an intricate pattern or in such small areas that they cannot be shown separately on the maps. The pattern and proportion of the soils or miscellaneous areas are somewhat similar in all areas. Alpha-Beta complex, 0 to 6 percent slopes, is an example.

An *association* is made up of two or more geographically associated soils or miscellaneous areas that are shown as one unit on the maps. Because of present or anticipated uses of the map units in the survey area, it was not considered practical or necessary to map the soils or miscellaneous areas separately. The pattern and relative proportion of the soils or miscellaneous areas are somewhat similar. Alpha-Beta association, 0 to 2 percent slopes, is an example.

An *undifferentiated group* is made up of two or more soils or miscellaneous areas that could be mapped individually but are mapped as one unit because similar interpretations can be made for use and management. The pattern and proportion

Custom Soil Resource Report

of the soils or miscellaneous areas in a mapped area are not uniform. An area can be made up of only one of the major soils or miscellaneous areas, or it can be made up of all of them. Alpha and Beta soils, 0 to 2 percent slopes, is an example.

Some surveys include *miscellaneous areas*. Such areas have little or no soil material and support little or no vegetation. Rock outcrop is an example.

Strafford County, New Hampshire

BzB—Buxton silt loam, 3 to 8 percent slopes

Map Unit Setting

National map unit symbol: 9d6p
Elevation: 0 to 260 feet
Mean annual precipitation: 36 to 71 inches
Mean annual air temperature: 39 to 55 degrees F
Frost-free period: 140 to 240 days
Farmland classification: All areas are prime farmland

Map Unit Composition

Buxton and similar soils: 85 percent
Minor components: 15 percent
Estimates are based on observations, descriptions, and transects of the mapunit.

Description of Buxton

Setting

Parent material: Glaciomarine

Typical profile

H1 - 0 to 10 inches: silt loam
H2 - 10 to 28 inches: silty clay loam
H3 - 28 to 43 inches: silty clay

Properties and qualities

Slope: 3 to 8 percent
Depth to restrictive feature: More than 80 inches
Drainage class: Moderately well drained
Runoff class: Very high
Capacity of the most limiting layer to transmit water (Ksat): Moderately low to moderately high (0.06 to 0.20 in/hr)
Depth to water table: About 12 to 24 inches
Frequency of flooding: None
Frequency of ponding: None
Available water capacity: Moderate (about 7.5 inches)

Interpretive groups

Land capability classification (irrigated): None specified
Land capability classification (nonirrigated): 2e
Hydrologic Soil Group: C/D
Ecological site: F145XY006CT - Semi-Rich Moist Lake Plain
Hydric soil rating: No

Minor Components

Elmwood

Percent of map unit: 10 percent
Hydric soil rating: No

Not named

Percent of map unit: 5 percent
Hydric soil rating: No

CsC—Charlton fine sandy loam, 8 to 15 percent slopes, very stony

Map Unit Setting

National map unit symbol: 2wh0p
Elevation: 0 to 1,570 feet
Mean annual precipitation: 36 to 71 inches
Mean annual air temperature: 39 to 55 degrees F
Frost-free period: 140 to 240 days
Farmland classification: Not prime farmland

Map Unit Composition

Charlton, very stony, and similar soils: 85 percent
Minor components: 15 percent
Estimates are based on observations, descriptions, and transects of the mapunit.

Description of Charlton, Very Stony

Setting

Landform: Hills, ground moraines, ridges
Landform position (two-dimensional): Backslope, shoulder, summit
Landform position (three-dimensional): Crest, side slope
Down-slope shape: Linear, convex
Across-slope shape: Convex
Parent material: Coarse-loamy melt-out till derived from granite, gneiss, and/or schist

Typical profile

Oe - 0 to 2 inches: moderately decomposed plant material
A - 2 to 4 inches: fine sandy loam
Bw - 4 to 27 inches: gravelly fine sandy loam
C - 27 to 65 inches: gravelly fine sandy loam

Properties and qualities

Slope: 8 to 15 percent
Surface area covered with cobbles, stones or boulders: 1.6 percent
Depth to restrictive feature: More than 80 inches
Drainage class: Well drained
Runoff class: Low
Capacity of the most limiting layer to transmit water (Ksat): Moderately low to high (0.14 to 14.17 in/hr)
Depth to water table: More than 80 inches
Frequency of flooding: None
Frequency of ponding: None
Maximum salinity: Nonsaline (0.0 to 1.9 mmhos/cm)
Available water capacity: Moderate (about 8.7 inches)

Interpretive groups

Land capability classification (irrigated): None specified
Land capability classification (nonirrigated): 6s
Hydrologic Soil Group: B

Custom Soil Resource Report

Ecological site: F144AY034CT - Well Drained Till Uplands
Hydric soil rating: No

Minor Components

Sutton, very stony

Percent of map unit: 5 percent
Landform: Hills, ground moraines
Landform position (two-dimensional): Footslope
Landform position (three-dimensional): Base slope
Down-slope shape: Concave
Across-slope shape: Linear
Hydric soil rating: No

Paxton, very stony

Percent of map unit: 5 percent
Landform: Drumlins, hills, ground moraines
Landform position (two-dimensional): Shoulder, summit, backslope
Landform position (three-dimensional): Side slope, crest
Down-slope shape: Linear, convex
Across-slope shape: Convex
Hydric soil rating: No

Chatfield, very stony

Percent of map unit: 3 percent
Landform: Hills, ridges
Landform position (two-dimensional): Summit, backslope, shoulder
Landform position (three-dimensional): Crest, side slope, nose slope
Down-slope shape: Convex
Across-slope shape: Linear, convex
Hydric soil rating: No

Leicester, very stony

Percent of map unit: 2 percent
Landform: Drainageways, ground moraines, hills, depressions
Landform position (two-dimensional): Toeslope, footslope
Landform position (three-dimensional): Base slope
Down-slope shape: Linear, concave
Across-slope shape: Concave
Hydric soil rating: Yes

HcB—Hollis-Charlton fine sandy loams, 3 to 8 percent slopes

Map Unit Setting

National map unit symbol: 9d7j
Elevation: 0 to 1,020 feet
Mean annual precipitation: 36 to 71 inches
Mean annual air temperature: 39 to 55 degrees F
Frost-free period: 120 to 240 days
Farmland classification: Farmland of local importance

Map Unit Composition

Hollis and similar soils: 55 percent

Charlton and similar soils: 35 percent

Minor components: 10 percent

Estimates are based on observations, descriptions, and transects of the mapunit.

Description of Hollis

Setting

Parent material: Till

Typical profile

H1 - 0 to 14 inches: fine sandy loam

H2 - 14 to 18 inches: bedrock

Properties and qualities

Slope: 3 to 8 percent

Depth to restrictive feature: 10 to 20 inches to lithic bedrock

Drainage class: Well drained

Runoff class: Very high

*Capacity of the most limiting layer to transmit water (Ksat): Moderately high to high
(0.60 to 6.00 in/hr)*

Depth to water table: More than 80 inches

Frequency of flooding: None

Frequency of ponding: None

Available water capacity: Very low (about 2.3 inches)

Interpretive groups

Land capability classification (irrigated): None specified

Land capability classification (nonirrigated): 3e

Hydrologic Soil Group: D

Ecological site: F144AY033MA - Shallow Dry Till Uplands

Hydric soil rating: No

Description of Charlton

Setting

Parent material: Till

Typical profile

H1 - 0 to 13 inches: fine sandy loam

H2 - 13 to 36 inches: fine sandy loam

H3 - 36 to 40 inches: gravelly loamy sand

Properties and qualities

Slope: 3 to 8 percent

Depth to restrictive feature: More than 80 inches

Drainage class: Well drained

Runoff class: Low

*Capacity of the most limiting layer to transmit water (Ksat): High (2.00 to 6.00
in/hr)*

Depth to water table: More than 80 inches

Frequency of flooding: None

Frequency of ponding: None

Available water capacity: Low (about 5.2 inches)

Interpretive groups

Land capability classification (irrigated): None specified
Land capability classification (nonirrigated): 2e
Hydrologic Soil Group: A
Ecological site: F144AY034CT - Well Drained Till Uplands
Hydric soil rating: No

Minor Components

Not named

Percent of map unit: 5 percent
Hydric soil rating: No

Buxton

Percent of map unit: 5 percent
Hydric soil rating: No

HcC—Hollis-Charlton fine sandy loams, 8 to 15 percent slopes

Map Unit Setting

National map unit symbol: 9d7k
Elevation: 0 to 1,080 feet
Mean annual precipitation: 36 to 71 inches
Mean annual air temperature: 39 to 55 degrees F
Frost-free period: 120 to 240 days
Farmland classification: Farmland of local importance

Map Unit Composition

Hollis and similar soils: 55 percent
Charlton and similar soils: 35 percent
Minor components: 10 percent
Estimates are based on observations, descriptions, and transects of the mapunit.

Description of Hollis

Setting

Parent material: Till

Typical profile

H1 - 0 to 14 inches: fine sandy loam
H2 - 14 to 18 inches: bedrock

Properties and qualities

Slope: 8 to 15 percent
Depth to restrictive feature: 10 to 20 inches to lithic bedrock
Drainage class: Well drained
Runoff class: Very high
Capacity of the most limiting layer to transmit water (Ksat): Moderately high to high
(0.60 to 6.00 in/hr)
Depth to water table: More than 80 inches

Custom Soil Resource Report

Frequency of flooding: None
Frequency of ponding: None
Available water capacity: Very low (about 2.3 inches)

Interpretive groups

Land capability classification (irrigated): None specified
Land capability classification (nonirrigated): 4e
Hydrologic Soil Group: D
Ecological site: F144AY033MA - Shallow Dry Till Uplands
Hydric soil rating: No

Description of Charlton

Setting

Parent material: Till

Typical profile

H1 - 0 to 13 inches: fine sandy loam
H2 - 13 to 36 inches: fine sandy loam
H3 - 36 to 40 inches: gravelly loamy sand

Properties and qualities

Slope: 8 to 15 percent
Depth to restrictive feature: More than 80 inches
Drainage class: Well drained
Runoff class: Low
Capacity of the most limiting layer to transmit water (Ksat): High (2.00 to 6.00 in/hr)
Depth to water table: More than 80 inches
Frequency of flooding: None
Frequency of ponding: None
Available water capacity: Low (about 5.2 inches)

Interpretive groups

Land capability classification (irrigated): None specified
Land capability classification (nonirrigated): 3e
Hydrologic Soil Group: A
Ecological site: F144AY034CT - Well Drained Till Uplands
Hydric soil rating: No

Minor Components

Not named

Percent of map unit: 5 percent
Hydric soil rating: No

Buxton

Percent of map unit: 5 percent
Hydric soil rating: No

HdB—Hollis-Charlton very rocky fine sandy loams, 3 to 8 percent slopes

Map Unit Setting

National map unit symbol: 9d7m
Elevation: 0 to 1,000 feet
Mean annual precipitation: 36 to 71 inches
Mean annual air temperature: 39 to 55 degrees F
Frost-free period: 120 to 240 days
Farmland classification: Not prime farmland

Map Unit Composition

Hollis and similar soils: 40 percent
Charlton and similar soils: 30 percent
Minor components: 30 percent
Estimates are based on observations, descriptions, and transects of the mapunit.

Description of Hollis

Setting

Parent material: Till

Typical profile

H1 - 0 to 14 inches: very stony fine sandy loam
H2 - 14 to 18 inches: bedrock

Properties and qualities

Slope: 3 to 8 percent
Surface area covered with cobbles, stones or boulders: 1.6 percent
Depth to restrictive feature: 10 to 20 inches to lithic bedrock
Drainage class: Well drained
Runoff class: Very high
Capacity of the most limiting layer to transmit water (Ksat): Moderately high to high
(0.60 to 6.00 in/hr)
Depth to water table: More than 80 inches
Frequency of flooding: None
Frequency of ponding: None
Available water capacity: Very low (about 2.0 inches)

Interpretive groups

Land capability classification (irrigated): None specified
Land capability classification (nonirrigated): 6s
Hydrologic Soil Group: D
Ecological site: F144AY033MA - Shallow Dry Till Uplands
Hydric soil rating: No

Description of Charlton

Setting

Parent material: Till

Custom Soil Resource Report

Typical profile

H1 - 0 to 13 inches: very stony fine sandy loam

H2 - 13 to 36 inches: fine sandy loam

H3 - 36 to 40 inches: gravelly loamy sand

Properties and qualities

Slope: 3 to 8 percent

Surface area covered with cobbles, stones or boulders: 1.6 percent

Depth to restrictive feature: More than 80 inches

Drainage class: Well drained

Runoff class: Low

Capacity of the most limiting layer to transmit water (Ksat): High (2.00 to 6.00 in/hr)

Depth to water table: More than 80 inches

Frequency of flooding: None

Frequency of ponding: None

Available water capacity: Low (about 5.4 inches)

Interpretive groups

Land capability classification (irrigated): None specified

Land capability classification (nonirrigated): 6s

Hydrologic Soil Group: A

Ecological site: F144AY034CT - Well Drained Till Uplands

Hydric soil rating: No

Minor Components

Rock outcrop

Percent of map unit: 10 percent

Hydric soil rating: No

Not named

Percent of map unit: 5 percent

Hydric soil rating: No

Sutton

Percent of map unit: 5 percent

Hydric soil rating: No

Buxton

Percent of map unit: 5 percent

Hydric soil rating: No

Leicester

Percent of map unit: 5 percent

Landform: Depressions

Hydric soil rating: Yes

HdC—Hollis-Charlton very rocky fine sandy loams, 8 to 15 percent slopes

Map Unit Setting

National map unit symbol: 9d7n
Elevation: 0 to 1,200 feet
Mean annual precipitation: 36 to 71 inches
Mean annual air temperature: 39 to 55 degrees F
Frost-free period: 120 to 240 days
Farmland classification: Not prime farmland

Map Unit Composition

Hollis and similar soils: 40 percent
Charlton and similar soils: 30 percent
Minor components: 30 percent
Estimates are based on observations, descriptions, and transects of the mapunit.

Description of Hollis

Setting

Parent material: Till

Typical profile

H1 - 0 to 14 inches: very stony fine sandy loam
H2 - 14 to 18 inches: bedrock

Properties and qualities

Slope: 8 to 15 percent
Surface area covered with cobbles, stones or boulders: 1.6 percent
Depth to restrictive feature: 10 to 20 inches to lithic bedrock
Drainage class: Well drained
Runoff class: Very high
Capacity of the most limiting layer to transmit water (Ksat): Moderately high to high
(0.60 to 6.00 in/hr)
Depth to water table: More than 80 inches
Frequency of flooding: None
Frequency of ponding: None
Available water capacity: Very low (about 2.0 inches)

Interpretive groups

Land capability classification (irrigated): None specified
Land capability classification (nonirrigated): 6s
Hydrologic Soil Group: D
Ecological site: F144AY033MA - Shallow Dry Till Uplands
Hydric soil rating: No

Description of Charlton

Setting

Parent material: Till

Typical profile

H1 - 0 to 13 inches: very stony fine sandy loam

H2 - 13 to 36 inches: fine sandy loam

H3 - 36 to 40 inches: gravelly loamy sand

Properties and qualities

Slope: 8 to 15 percent

Surface area covered with cobbles, stones or boulders: 1.6 percent

Depth to restrictive feature: More than 80 inches

Drainage class: Well drained

Runoff class: Low

Capacity of the most limiting layer to transmit water (Ksat): High (2.00 to 6.00 in/hr)

Depth to water table: More than 80 inches

Frequency of flooding: None

Frequency of ponding: None

Available water capacity: Low (about 5.4 inches)

Interpretive groups

Land capability classification (irrigated): None specified

Land capability classification (nonirrigated): 6s

Hydrologic Soil Group: A

Ecological site: F144AY034CT - Well Drained Till Uplands

Hydric soil rating: No

Minor Components

Rock outcrop

Percent of map unit: 10 percent

Hydric soil rating: No

Not named

Percent of map unit: 10 percent

Hydric soil rating: No

Woodbridge

Percent of map unit: 5 percent

Hydric soil rating: No

Sutton

Percent of map unit: 5 percent

Hydric soil rating: No

HeD—Hollis-Charlton extremely rocky fine sandy loams, 8 to 25 percent slopes

Map Unit Setting

National map unit symbol: 9d7q
Elevation: 0 to 1,180 feet
Mean annual precipitation: 36 to 71 inches
Mean annual air temperature: 39 to 55 degrees F
Frost-free period: 120 to 240 days
Farmland classification: Not prime farmland

Map Unit Composition

Hollis and similar soils: 30 percent
Charlton and similar soils: 25 percent
Minor components: 45 percent
Estimates are based on observations, descriptions, and transects of the mapunit.

Description of Hollis

Setting

Parent material: Till

Typical profile

H1 - 0 to 14 inches: extremely stony fine sandy loam
H2 - 14 to 18 inches: bedrock

Properties and qualities

Slope: 8 to 25 percent
Surface area covered with cobbles, stones or boulders: 1.6 percent
Depth to restrictive feature: 10 to 20 inches to lithic bedrock
Drainage class: Well drained
Runoff class: Very high
Capacity of the most limiting layer to transmit water (Ksat): Moderately high to high
(0.60 to 6.00 in/hr)
Depth to water table: More than 80 inches
Frequency of flooding: None
Frequency of ponding: None
Available water capacity: Very low (about 2.0 inches)

Interpretive groups

Land capability classification (irrigated): None specified
Land capability classification (nonirrigated): 6s
Hydrologic Soil Group: D
Ecological site: F144AY033MA - Shallow Dry Till Uplands
Hydric soil rating: No

Description of Charlton

Setting

Parent material: Till

Typical profile

H1 - 0 to 13 inches: extremely stony fine sandy loam

H2 - 13 to 36 inches: fine sandy loam

H3 - 36 to 40 inches: gravelly loamy sand

Properties and qualities

Slope: 8 to 25 percent

Surface area covered with cobbles, stones or boulders: 1.6 percent

Depth to restrictive feature: More than 80 inches

Drainage class: Well drained

Runoff class: Low

Capacity of the most limiting layer to transmit water (Ksat): High (2.00 to 6.00 in/hr)

Depth to water table: More than 80 inches

Frequency of flooding: None

Frequency of ponding: None

Available water capacity: Low (about 5.4 inches)

Interpretive groups

Land capability classification (irrigated): None specified

Land capability classification (nonirrigated): 6s

Hydrologic Soil Group: A

Ecological site: F144AY034CT - Well Drained Till Uplands

Hydric soil rating: No

Minor Components

Rock outcrop

Percent of map unit: 25 percent

Hydric soil rating: No

Not named

Percent of map unit: 10 percent

Hydric soil rating: No

Leicester

Percent of map unit: 5 percent

Landform: Depressions

Hydric soil rating: Yes

Sutton

Percent of map unit: 5 percent

Hydric soil rating: No

Sb—Saugatuck loamy sand

Map Unit Setting

National map unit symbol: 9d8r
Elevation: 300 to 1,000 feet
Mean annual precipitation: 27 to 71 inches
Mean annual air temperature: 39 to 55 degrees F
Frost-free period: 125 to 240 days
Farmland classification: Not prime farmland

Map Unit Composition

Saugatuck and similar soils: 85 percent
Minor components: 15 percent
Estimates are based on observations, descriptions, and transects of the mapunit.

Description of Saugatuck

Setting

Landform: Outwash terraces
Parent material: Outwash

Typical profile

H1 - 0 to 4 inches: loamy sand
H2 - 4 to 7 inches: sand
H3 - 7 to 26 inches: loamy sand
H4 - 26 to 42 inches: sand

Properties and qualities

Slope: 0 to 3 percent
Depth to restrictive feature: 10 to 16 inches to undefined
Drainage class: Poorly drained
Runoff class: High
Capacity of the most limiting layer to transmit water (Ksat): Moderately high to high
(0.60 to 2.00 in/hr)
Depth to water table: About 0 to 12 inches
Frequency of flooding: None
Frequency of ponding: None
Available water capacity: Very low (about 1.1 inches)

Interpretive groups

Land capability classification (irrigated): None specified
Land capability classification (nonirrigated): 4w
Hydrologic Soil Group: B/D
Hydric soil rating: Yes

Minor Components

Not named wet

Percent of map unit: 15 percent

Custom Soil Resource Report

Landform: Outwash terraces
Hydric soil rating: Yes

SfC—Suffield silt loam, 8 to 15 percent slopes

Map Unit Setting

National map unit symbol: 9d8v
Elevation: 0 to 250 feet
Mean annual precipitation: 36 to 71 inches
Mean annual air temperature: 39 to 55 degrees F
Frost-free period: 140 to 240 days
Farmland classification: Farmland of statewide importance

Map Unit Composition

Suffield and similar soils: 85 percent
Minor components: 15 percent
Estimates are based on observations, descriptions, and transects of the mapunit.

Description of Suffield

Typical profile

H1 - 0 to 19 inches: silt loam
H2 - 19 to 28 inches: silt loam
H3 - 28 to 41 inches: silty clay

Properties and qualities

Slope: 8 to 15 percent
Depth to restrictive feature: More than 80 inches
Drainage class: Well drained
Runoff class: High
Capacity of the most limiting layer to transmit water (Ksat): Very low to moderately high (0.00 to 0.20 in/hr)
Depth to water table: More than 80 inches
Frequency of flooding: None
Frequency of ponding: None
Available water capacity: Moderate (about 7.4 inches)

Interpretive groups

Land capability classification (irrigated): None specified
Land capability classification (nonirrigated): 3e
Hydrologic Soil Group: C
Ecological site: F144AY017NH - Well Drained Lake Plain
Hydric soil rating: No

Minor Components

Not named

Percent of map unit: 9 percent
Hydric soil rating: No

Buxton

Percent of map unit: 5 percent
Hydric soil rating: No

Rock outcrop

Percent of map unit: 1 percent
Hydric soil rating: No

W—Water

Map Unit Composition

Water (less than 40 acres): 100 percent
Estimates are based on observations, descriptions, and transects of the mapunit.

WfB—Windsor loamy fine sand, clay subsoil variant, 0 to 8 percent slopes

Map Unit Setting

National map unit symbol: 9d9b
Elevation: 0 to 280 feet
Mean annual precipitation: 36 to 71 inches
Mean annual air temperature: 39 to 55 degrees F
Frost-free period: 140 to 240 days
Farmland classification: All areas are prime farmland

Map Unit Composition

Windsor variant and similar soils: 85 percent
Minor components: 15 percent
Estimates are based on observations, descriptions, and transects of the mapunit.

Description of Windsor Variant

Typical profile

H1 - 0 to 26 inches: loamy fine sand
H2 - 26 to 30 inches: loamy sand
H3 - 30 to 42 inches: silt loam

Properties and qualities

Slope: 0 to 8 percent
Depth to restrictive feature: More than 80 inches
Drainage class: Well drained
Runoff class: Low
Capacity of the most limiting layer to transmit water (Ksat): Moderately high (0.20 to 0.60 in/hr)
Depth to water table: About 24 to 36 inches
Frequency of flooding: None
Frequency of ponding: None
Available water capacity: Low (about 5.1 inches)

Custom Soil Resource Report

Interpretive groups

Land capability classification (irrigated): None specified

Land capability classification (nonirrigated): 3s

Hydrologic Soil Group: A

Ecological site: F144AY022MA - Dry Outwash

Hydric soil rating: No

Minor Components

Not named

Percent of map unit: 15 percent

Hydric soil rating: No

Soil Information for All Uses

Soil Properties and Qualities

The Soil Properties and Qualities section includes various soil properties and qualities displayed as thematic maps with a summary table for the soil map units in the selected area of interest. A single value or rating for each map unit is generated by aggregating the interpretive ratings of individual map unit components. This aggregation process is defined for each property or quality.

Soil Qualities and Features

Soil qualities are behavior and performance attributes that are not directly measured, but are inferred from observations of dynamic conditions and from soil properties. Example soil qualities include natural drainage, and frost action. Soil features are attributes that are not directly part of the soil. Example soil features include slope and depth to restrictive layer. These features can greatly impact the use and management of the soil.

Hydrologic Soil Group

Hydrologic soil groups are based on estimates of runoff potential. Soils are assigned to one of four groups according to the rate of water infiltration when the soils are not protected by vegetation, are thoroughly wet, and receive precipitation from long-duration storms.

The soils in the United States are assigned to four groups (A, B, C, and D) and three dual classes (A/D, B/D, and C/D). The groups are defined as follows:

Group A. Soils having a high infiltration rate (low runoff potential) when thoroughly wet. These consist mainly of deep, well drained to excessively drained sands or gravelly sands. These soils have a high rate of water transmission.

Group B. Soils having a moderate infiltration rate when thoroughly wet. These consist chiefly of moderately deep or deep, moderately well drained or well drained soils that have moderately fine texture to moderately coarse texture. These soils have a moderate rate of water transmission.

Custom Soil Resource Report

Group C. Soils having a slow infiltration rate when thoroughly wet. These consist chiefly of soils having a layer that impedes the downward movement of water or soils of moderately fine texture or fine texture. These soils have a slow rate of water transmission.

Group D. Soils having a very slow infiltration rate (high runoff potential) when thoroughly wet. These consist chiefly of clays that have a high shrink-swell potential, soils that have a high water table, soils that have a claypan or clay layer at or near the surface, and soils that are shallow over nearly impervious material. These soils have a very slow rate of water transmission.

If a soil is assigned to a dual hydrologic group (A/D, B/D, or C/D), the first letter is for drained areas and the second is for undrained areas. Only the soils that in their natural condition are in group D are assigned to dual classes.

Custom Soil Resource Report Map—Hydrologic Soil Group



Soil Map may not be valid at this scale.

Map Scale: 1:4,340 if printed on A portrait (8.5" x 11") sheet.

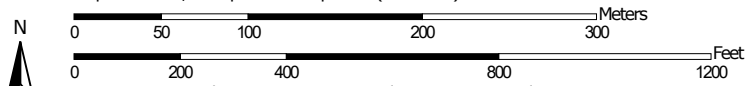

Map projection: Web Mercator Corner coordinates: WGS84 Edge tics: UTM Zone 19N WGS84

MAP LEGEND

Area of Interest (AOI)









 Area of Interest (AOI)

Soils

Soil Rating Polygons





-  A
-  A/D
-  B
-  B/D
-  C
-  C/D
-  D
-  Not rated or not available

Soil Rating Lines

-  A
-  A/D
-  B
-  B/D
-  C
-  C/D
-  D
-  Not rated or not available

Soil Rating Points





-  A
-  A/D
-  B
-  B/D

-  C
-  C/D
-  D
-  Not rated or not available

Water Features

 Streams and Canals

Transportation

-  Rails
-  Interstate Highways
-  US Routes
-  Major Roads
-  Local Roads

Background

 Aerial Photography

MAP INFORMATION

The soil surveys that comprise your AOI were mapped at 1:20,000.

Warning: Soil Map may not be valid at this scale.

Enlargement of maps beyond the scale of mapping can cause misunderstanding of the detail of mapping and accuracy of soil line placement. The maps do not show the small areas of contrasting soils that could have been shown at a more detailed scale.

Please rely on the bar scale on each map sheet for map measurements.

Source of Map: Natural Resources Conservation Service
 Web Soil Survey URL:
 Coordinate System: Web Mercator (EPSG:3857)

Maps from the Web Soil Survey are based on the Web Mercator projection, which preserves direction and shape but distorts distance and area. A projection that preserves area, such as the Albers equal-area conic projection, should be used if more accurate calculations of distance or area are required.

This product is generated from the USDA-NRCS certified data as of the version date(s) listed below.

Soil Survey Area: Strafford County, New Hampshire
 Survey Area Data: Version 20, May 29, 2020

Soil map units are labeled (as space allows) for map scales 1:50,000 or larger.

Date(s) aerial images were photographed: Dec 31, 2009—Sep 9, 2017

The orthophoto or other base map on which the soil lines were compiled and digitized probably differs from the background imagery displayed on these maps. As a result, some minor shifting of map unit boundaries may be evident.

Table—Hydrologic Soil Group

Map unit symbol	Map unit name	Rating	Acres in AOI	Percent of AOI
BzB	Buxton silt loam, 3 to 8 percent slopes	C/D	31.7	33.2%
CsC	Charlton fine sandy loam, 8 to 15 percent slopes, very stony	B	0.8	0.9%
HcB	Hollis-Charlton fine sandy loams, 3 to 8 percent slopes	D	10.0	10.5%
HcC	Hollis-Charlton fine sandy loams, 8 to 15 percent slopes	D	3.0	3.1%
HdB	Hollis-Charlton very rocky fine sandy loams, 3 to 8 percent slopes	D	8.2	8.5%
HdC	Hollis-Charlton very rocky fine sandy loams, 8 to 15 percent slopes	D	0.0	0.0%
HeD	Hollis-Charlton extremely rocky fine sandy loams, 8 to 25 percent slopes		7.5	7.8%
Sb	Saugatuck loamy sand	B/D	0.7	0.7%
SfC	Suffield silt loam, 8 to 15 percent slopes	C	26.9	28.1%
W	Water		4.1	4.3%
WfB	Windsor loamy fine sand, clay subsoil variant, 0 to 8 percent slopes	A	2.7	2.8%
Totals for Area of Interest			95.6	100.0%

Rating Options—Hydrologic Soil Group

Aggregation Method: Dominant Condition

Component Percent Cutoff: None Specified

Tie-break Rule: Higher

References

- American Association of State Highway and Transportation Officials (AASHTO). 2004. Standard specifications for transportation materials and methods of sampling and testing. 24th edition.
- American Society for Testing and Materials (ASTM). 2005. Standard classification of soils for engineering purposes. ASTM Standard D2487-00.
- Cowardin, L.M., V. Carter, F.C. Golet, and E.T. LaRoe. 1979. Classification of wetlands and deep-water habitats of the United States. U.S. Fish and Wildlife Service FWS/OBS-79/31.
- Federal Register. July 13, 1994. Changes in hydric soils of the United States.
- Federal Register. September 18, 2002. Hydric soils of the United States.
- Hurt, G.W., and L.M. Vasilas, editors. Version 6.0, 2006. Field indicators of hydric soils in the United States.
- National Research Council. 1995. Wetlands: Characteristics and boundaries.
- Soil Survey Division Staff. 1993. Soil survey manual. Soil Conservation Service. U.S. Department of Agriculture Handbook 18. http://www.nrcs.usda.gov/wps/portal/nrcs/detail/national/soils/?cid=nrcs142p2_054262
- Soil Survey Staff. 1999. Soil taxonomy: A basic system of soil classification for making and interpreting soil surveys. 2nd edition. Natural Resources Conservation Service, U.S. Department of Agriculture Handbook 436. http://www.nrcs.usda.gov/wps/portal/nrcs/detail/national/soils/?cid=nrcs142p2_053577
- Soil Survey Staff. 2010. Keys to soil taxonomy. 11th edition. U.S. Department of Agriculture, Natural Resources Conservation Service. http://www.nrcs.usda.gov/wps/portal/nrcs/detail/national/soils/?cid=nrcs142p2_053580
- Tiner, R.W., Jr. 1985. Wetlands of Delaware. U.S. Fish and Wildlife Service and Delaware Department of Natural Resources and Environmental Control, Wetlands Section.
- United States Army Corps of Engineers, Environmental Laboratory. 1987. Corps of Engineers wetlands delineation manual. Waterways Experiment Station Technical Report Y-87-1.
- United States Department of Agriculture, Natural Resources Conservation Service. National forestry manual. http://www.nrcs.usda.gov/wps/portal/nrcs/detail/soils/home/?cid=nrcs142p2_053374
- United States Department of Agriculture, Natural Resources Conservation Service. National range and pasture handbook. <http://www.nrcs.usda.gov/wps/portal/nrcs/detail/national/landuse/rangepasture/?cid=stelprdb1043084>

Custom Soil Resource Report

United States Department of Agriculture, Natural Resources Conservation Service. National soil survey handbook, title 430-VI. http://www.nrcs.usda.gov/wps/portal/nrcs/detail/soils/scientists/?cid=nrcs142p2_054242

United States Department of Agriculture, Natural Resources Conservation Service. 2006. Land resource regions and major land resource areas of the United States, the Caribbean, and the Pacific Basin. U.S. Department of Agriculture Handbook 296. http://www.nrcs.usda.gov/wps/portal/nrcs/detail/national/soils/?cid=nrcs142p2_053624

United States Department of Agriculture, Soil Conservation Service. 1961. Land capability classification. U.S. Department of Agriculture Handbook 210. http://www.nrcs.usda.gov/Internet/FSE_DOCUMENTS/nrcs142p2_052290.pdf

**1.3 Extreme Precipitation Tables
(Northeast Regional Climate Center)**

Extreme Precipitation Tables

Northeast Regional Climate Center

Data represents point estimates calculated from partial duration series. All precipitation amounts are displayed in inches.

Smoothing	No
State	New Hampshire
Location	
Longitude	70.923 degrees West
Latitude	43.133 degrees North
Elevation	0 feet
Date/Time	Tue, 20 Oct 2020 14:53:49 -0400

Extreme Precipitation Estimates

	5min	10min	15min	30min	60min	120min		1hr	2hr	3hr	6hr	12hr	24hr	48hr		1day	2day	4day	7day	10day	
1yr	0.26	0.40	0.49	0.66	0.81	1.00	1yr	0.70	0.98	1.13	1.59	2.03	2.61	2.84	1yr	2.31	2.74	3.14	3.86	4.44	1yr
2yr	0.32	0.49	0.61	0.82	1.01	1.19	2yr	0.88	1.17	1.39	1.86	2.41	3.14	3.48	2yr	2.78	3.34	3.84	4.57	5.21	2yr
5yr	0.37	0.57	0.70	0.96	1.23	1.48	5yr	1.06	1.44	1.72	2.32	2.96	3.98	4.46	5yr	3.52	4.29	4.90	5.79	6.55	5yr
10yr	0.41	0.63	0.78	1.10	1.42	1.73	10yr	1.22	1.69	2.02	2.73	3.46	4.76	5.39	10yr	4.21	5.18	5.90	6.92	7.80	10yr
25yr	0.48	0.74	0.91	1.31	1.72	2.14	25yr	1.48	2.09	2.51	3.40	4.26	6.03	6.91	25yr	5.34	6.65	7.53	8.78	9.83	25yr
50yr	0.54	0.83	1.03	1.48	2.00	2.51	50yr	1.72	2.46	2.96	4.01	4.99	7.22	8.36	50yr	6.39	8.04	9.06	10.51	11.72	50yr
100yr	0.62	0.93	1.17	1.69	2.32	2.95	100yr	2.00	2.89	3.48	4.73	5.84	8.64	10.11	100yr	7.65	9.72	10.91	12.58	13.97	100yr
200yr	0.70	1.05	1.33	1.93	2.69	3.48	200yr	2.32	3.40	4.10	5.59	6.84	10.36	12.22	200yr	9.16	11.75	13.14	15.07	16.66	200yr
500yr	0.83	1.24	1.59	2.31	3.29	4.31	500yr	2.84	4.22	5.10	6.97	8.45	13.16	15.72	500yr	11.64	15.12	16.81	19.15	21.05	500yr

Lower Confidence Limits

	5min	10min	15min	30min	60min	120min		1hr	2hr	3hr	6hr	12hr	24hr	48hr		1day	2day	4day	7day	10day	
1yr	0.24	0.37	0.45	0.60	0.74	0.90	1yr	0.64	0.88	0.91	1.26	1.56	2.02	2.52	1yr	1.79	2.42	2.93	3.27	4.01	1yr
2yr	0.31	0.49	0.60	0.81	1.00	1.18	2yr	0.86	1.16	1.37	1.83	2.36	3.04	3.39	2yr	2.69	3.26	3.74	4.46	5.05	2yr
5yr	0.35	0.54	0.67	0.92	1.16	1.40	5yr	1.01	1.37	1.62	2.15	2.78	3.72	4.14	5yr	3.29	3.98	4.59	5.43	6.14	5yr
10yr	0.38	0.59	0.73	1.02	1.32	1.60	10yr	1.14	1.57	1.82	2.45	3.13	4.30	4.82	10yr	3.80	4.63	5.34	6.30	7.08	10yr
25yr	0.44	0.67	0.83	1.18	1.56	1.91	25yr	1.35	1.87	2.11	2.85	3.66	5.03	5.87	25yr	4.45	5.65	6.54	7.68	8.56	25yr
50yr	0.48	0.74	0.92	1.32	1.77	2.19	50yr	1.53	2.14	2.36	3.20	4.11	5.77	6.81	50yr	5.11	6.55	7.63	8.92	9.87	50yr
100yr	0.54	0.82	1.02	1.48	2.03	2.51	100yr	1.75	2.45	2.64	3.59	4.60	6.60	7.89	100yr	5.84	7.59	8.91	10.35	11.35	100yr
200yr	0.60	0.90	1.15	1.66	2.31	2.87	200yr	2.00	2.80	2.94	4.01	5.14	7.55	9.15	200yr	6.68	8.80	10.41	12.02	13.08	200yr
500yr	0.70	1.05	1.34	1.95	2.78	3.45	500yr	2.40	3.37	3.42	4.65	5.98	8.99	11.12	500yr	7.95	10.69	12.80	14.67	15.72	500yr

Upper Confidence Limits

	5min	10min	15min	30min	60min	120min		1hr	2hr	3hr	6hr	12hr	24hr	48hr		1day	2day	4day	7day	10day	
1yr	0.28	0.43	0.53	0.71	0.87	1.08	1yr	0.75	1.05	1.24	1.75	2.22	2.84	3.03	1yr	2.51	2.91	3.38	4.18	4.78	1yr
2yr	0.33	0.51	0.62	0.84	1.04	1.25	2yr	0.90	1.22	1.48	1.95	2.50	3.26	3.58	2yr	2.88	3.44	3.95	4.71	5.40	2yr
5yr	0.39	0.60	0.75	1.03	1.31	1.58	5yr	1.13	1.55	1.85	2.50	3.19	4.23	4.77	5yr	3.74	4.59	5.22	6.16	6.93	5yr
10yr	0.46	0.70	0.87	1.21	1.57	1.92	10yr	1.35	1.88	2.23	3.04	3.84	5.21	5.94	10yr	4.61	5.71	6.48	7.56	8.45	10yr
25yr	0.55	0.84	1.05	1.50	1.97	2.48	25yr	1.70	2.42	2.87	3.96	4.93	7.05	7.95	25yr	6.24	7.65	8.59	9.94	11.01	25yr
50yr	0.64	0.97	1.21	1.74	2.34	2.99	50yr	2.02	2.92	3.48	4.83	5.99	8.73	9.93	50yr	7.73	9.55	10.65	12.21	13.47	50yr
100yr	0.74	1.12	1.41	2.03	2.79	3.61	100yr	2.40	3.53	4.23	5.91	7.27	10.81	12.40	100yr	9.57	11.92	13.19	15.02	16.48	100yr
200yr	0.86	1.29	1.64	2.37	3.31	4.38	200yr	2.86	4.28	5.14	7.23	8.81	13.43	15.50	200yr	11.88	14.91	16.34	18.47	20.19	200yr
500yr	1.05	1.56	2.01	2.92	4.15	5.63	500yr	3.58	5.50	6.63	9.47	11.40	17.92	20.82	500yr	15.86	20.02	21.69	24.30	26.43	500yr



**SECTION 2.0 - DRAINAGE CALCULATIONS,
ANALYSIS & DESIGN**

2.1 Infiltration Volume Calculations



GENERAL CALCULATIONS - WQV and WQF (optional worksheet)

This worksheet may be useful when designing a BMP **that does not fit into one of the specific worksheets already provided** (i.e. for a technology which is not a stormwater wetland, infiltration practice, etc.)

Water Quality Volume (WQV)

2.98	ac	A = Area draining to the practice
1.67	ac	A _i = Impervious area draining to the practice
0.56	decimal	I = Percent impervious area draining to the practice, in decimal form
0.55	unitless	R _v = Runoff coefficient = 0.05 + (0.9 x I)
1.65	ac-in	WQV = 1" x R _v x A
5,982	cf	WQV conversion (ac-in x 43,560 sf/ac x 1ft/12")

Water Quality Flow (WQF)

1	inches	P = Amount of rainfall. For WQF in NH, P = 1".
0.55	inches	Q = Water quality depth. Q = WQV/A
95	unitless	CN = Unit peak discharge curve number. CN = 1000 / (10 + 5P + 10Q - 10 * [Q ² + 1.25 * Q * P] ^{0.5})
0.5	inches	S = Potential maximum retention. S = (1000/CN) - 10
0.109	inches	I _a = Initial abstraction. I _a = 0.2S
	minutes	T _c = Time of Concentration
	cfs/mi ² /in	q _u is the unit peak discharge. Obtain this value from TR-55 exhibits 4-II and 4-III.
-	cfs	WQF = q _u x WQV. Conversion: to convert "cfs/mi ² /in * ac-in" to "cfs" multiply by 1mi ² /640ac.

Designer's Notes: This sheet is being used to calculate the Water Quality Volume for the entire drainage area of the project. This value is used in support of Town of Durham infiltration requirements.

The Town requires volume be infiltrated based on a ratio per Hydrologic Soil Group disturbed. This requirement was interpreted to relate to net impervious surface, and an average volume ratio was calculated for the project site as follows:

HSG A Ratio: 1.00 Net Impervious: 0.000 acre

HSG B Ratio: 0.75 Net Impervious: 0.387 acre

HSG C Ratio: 0.40 Net Impervious: 0.677 acre

HSG D Ratio: 0.16 Net Impervious: -0.005 acre

Overall net impervious area: 1.069 acre

Weighted average for site: 0.525

Site overall WQV: 5982 cf

Required infiltration volume: 0.525 x 5,982 cf = 3,141 cf

Provided infiltration volume: 5,301 cf

2.2 BMP Worksheets for all Treatment Systems

2.3 Pre-Development Analysis

2.3 Pre-development Analysis

A pre-development analysis covering 128,764 square feet which includes the area to be disturbed by the proposed project. The site has been divided into two pre-development subcatchment area., Subcatchments EX-1 and EX-2 representing the areas draining directly to Drainage Point 1 (Dp-1) and Drainage Point 2 (Dp-2) respectively. EX-1 models area at the front of the site which drains to a point on Main Street, and consists primarily of the existing developed areas at the front of the project site. Drainage Point 2 is in the south of the site, and represents flow toward college brook. EX-2 represents the area draining to Dp-2, and consists primarily of forested slope, but includes a portion of the existing developed area at the north end of the project site.

For more detailed information on the pre-developed area, including watershed areas and drainage paths, see attached drainage plans found in **Section 3** and the HydroCAD area listing found in **Section 2.3.1**. A pre- versus post- development comparison flow rate table for the 1 inch; 2, 10, 25, 50, and 100 year storm events can be found in **Table 1.0** in **Section 1.1.1**.

A High Intensity Soil Survey (HISS) within the work area was completed by Joseph W. Noel, Certified Soil Scientist #017, on October 16, 2020. This information can be found included on the Existing Conditions Plan.

**2.3.1 Pre Development
Diagram, Area Listing, Soil Listing**

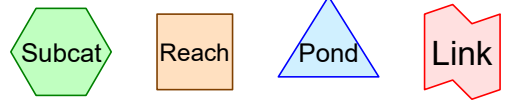
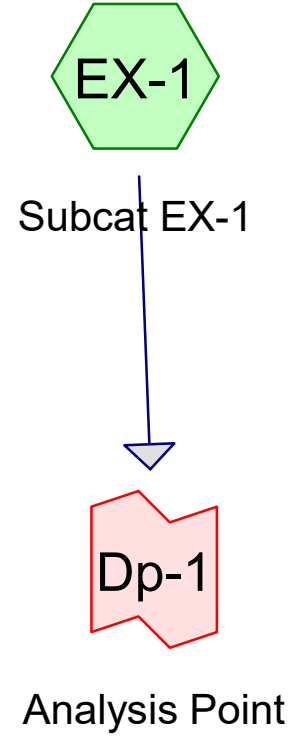
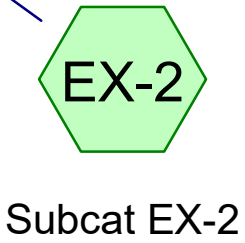
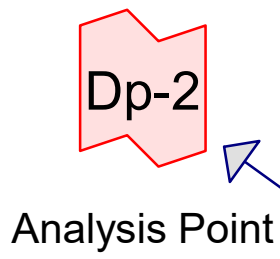

Area Listing (selected nodes)

Area (sq-ft)	CN	Description (subcatchment-numbers)
6,205	61	>75% Grass cover, Good, HSG B (EX-1)
1,321	74	>75% Grass cover, Good, HSG C (EX-1, EX-2)
9,052	80	>75% Grass cover, Good, HSG D (EX-1, EX-2)
508	98	Existing Concrete Pads, HSG C (EX-2)
223	98	Existing Concrete Pads, HSG D (EX-1, EX-2)
25	98	Existing Decks and Steps, HSG B (EX-1)
6	98	Existing Decks and Steps, HSG C (EX-2)
493	98	Existing Decks and Steps, HSG D (EX-1, EX-2)
227	98	Paved parking, HSG B (EX-1)
2,767	98	Paved parking, HSG C (EX-2)
17,991	98	Paved parking, HSG D (EX-1, EX-2)
767	98	Roofs, HSG B (EX-1)
3,732	98	Roofs, HSG D (EX-1, EX-2)
18,332	55	Woods, Good, HSG B (EX-1)
65,194	70	Woods, Good, HSG C (EX-1)
1,919	77	Woods, Good, HSG D (EX-1)

Soil Listing (selected nodes)

Area (sq-ft)	Soil Group	Subcatchment Numbers
0	HSG A	
25,556	HSG B	EX-1
69,797	HSG C	EX-1, EX-2
33,411	HSG D	EX-1, EX-2
0	Other	

**2.3.2 Pre-Development
Node Listing for the 2, 10, 25, 50, and 100 Year Storm Events**

Time span=0.00-72.00 hrs, dt=0.05 hrs, 1441 points
Runoff by SCS TR-20 method, UH=SCS, Weighted-CN
Reach routing by Stor-Ind+Trans method - Pond routing by Stor-Ind method

Subcatchment EX-1: Subcat EX-1 Runoff Area=117,882 sf 15.74% Impervious Runoff Depth=0.01"
Flow Length=653' Tc=11.0 min CN=72 Runoff=0.00 cfs 118 cf

Subcatchment EX-2: Subcat EX-2 Runoff Area=10,882 sf 75.28% Impervious Runoff Depth=0.45"
Flow Length=154' Tc=6.0 min CN=93 Runoff=0.13 cfs 408 cf

Link Dp-1: Analysis Point Inflow=0.00 cfs 118 cf
Primary=0.00 cfs 118 cf

Link Dp-2: Analysis Point Inflow=0.13 cfs 408 cf
Primary=0.13 cfs 408 cf

Total Runoff Area = 128,764 sf Runoff Volume = 526 cf Average Runoff Depth = 0.05"
79.23% Pervious = 102,024 sf 20.77% Impervious = 26,741 sf

Time span=0.00-72.00 hrs, dt=0.05 hrs, 1441 points
Runoff by SCS TR-20 method, UH=SCS, Weighted-CN
Reach routing by Stor-Ind+Trans method - Pond routing by Stor-Ind method

Subcatchment EX-1: Subcat EX-1

Runoff Area=117,882 sf 15.74% Impervious Runoff Depth=0.89"
Flow Length=653' Tc=11.0 min CN=72 Runoff=2.17 cfs 8,769 cf

Subcatchment EX-2: Subcat EX-2

Runoff Area=10,882 sf 75.28% Impervious Runoff Depth=2.39"
Flow Length=154' Tc=6.0 min CN=93 Runoff=0.66 cfs 2,166 cf

Link Dp-1: Analysis Point

Inflow=2.17 cfs 8,769 cf
Primary=2.17 cfs 8,769 cf

Link Dp-2: Analysis Point

Inflow=0.66 cfs 2,166 cf
Primary=0.66 cfs 2,166 cf

Total Runoff Area = 128,764 sf Runoff Volume = 10,935 cf Average Runoff Depth = 1.02"
79.23% Pervious = 102,024 sf 20.77% Impervious = 26,741 sf

Time span=0.00-72.00 hrs, dt=0.05 hrs, 1441 points
Runoff by SCS TR-20 method, UH=SCS, Weighted-CN
Reach routing by Stor-Ind+Trans method - Pond routing by Stor-Ind method

Subcatchment EX-1: Subcat EX-1

Runoff Area=117,882 sf 15.74% Impervious Runoff Depth=2.01"
Flow Length=653' Tc=11.0 min CN=72 Runoff=5.29 cfs 19,792 cf

Subcatchment EX-2: Subcat EX-2

Runoff Area=10,882 sf 75.28% Impervious Runoff Depth=3.96"
Flow Length=154' Tc=6.0 min CN=93 Runoff=1.07 cfs 3,593 cf

Link Dp-1: Analysis Point

Inflow=5.29 cfs 19,792 cf
Primary=5.29 cfs 19,792 cf

Link Dp-2: Analysis Point

Inflow=1.07 cfs 3,593 cf
Primary=1.07 cfs 3,593 cf

Total Runoff Area = 128,764 sf Runoff Volume = 23,385 cf Average Runoff Depth = 2.18"
79.23% Pervious = 102,024 sf 20.77% Impervious = 26,741 sf

Time span=0.00-72.00 hrs, dt=0.05 hrs, 1441 points
Runoff by SCS TR-20 method, UH=SCS, Weighted-CN
Reach routing by Stor-Ind+Trans method - Pond routing by Stor-Ind method

Subcatchment EX-1: Subcat EX-1

Runoff Area=117,882 sf 15.74% Impervious Runoff Depth=3.02"
Flow Length=653' Tc=11.0 min CN=72 Runoff=8.03 cfs 29,645 cf

Subcatchment EX-2: Subcat EX-2

Runoff Area=10,882 sf 75.28% Impervious Runoff Depth=5.21"
Flow Length=154' Tc=6.0 min CN=93 Runoff=1.38 cfs 4,727 cf

Link Dp-1: Analysis Point

Inflow=8.03 cfs 29,645 cf
Primary=8.03 cfs 29,645 cf

Link Dp-2: Analysis Point

Inflow=1.38 cfs 4,727 cf
Primary=1.38 cfs 4,727 cf

Total Runoff Area = 128,764 sf Runoff Volume = 34,372 cf Average Runoff Depth = 3.20"
79.23% Pervious = 102,024 sf 20.77% Impervious = 26,741 sf

Time span=0.00-72.00 hrs, dt=0.05 hrs, 1441 points
Runoff by SCS TR-20 method, UH=SCS, Weighted-CN
Reach routing by Stor-Ind+Trans method - Pond routing by Stor-Ind method

Subcatchment EX-1: Subcat EX-1

Runoff Area=117,882 sf 15.74% Impervious Runoff Depth=4.02"
Flow Length=653' Tc=11.0 min CN=72 Runoff=10.72 cfs 39,463 cf

Subcatchment EX-2: Subcat EX-2

Runoff Area=10,882 sf 75.28% Impervious Runoff Depth=6.39"
Flow Length=154' Tc=6.0 min CN=93 Runoff=1.68 cfs 5,794 cf

Link Dp-1: Analysis Point

Inflow=10.72 cfs 39,463 cf
Primary=10.72 cfs 39,463 cf

Link Dp-2: Analysis Point

Inflow=1.68 cfs 5,794 cf
Primary=1.68 cfs 5,794 cf

Total Runoff Area = 128,764 sf Runoff Volume = 45,257 cf Average Runoff Depth = 4.22"
79.23% Pervious = 102,024 sf 20.77% Impervious = 26,741 sf

Time span=0.00-72.00 hrs, dt=0.05 hrs, 1441 points
Runoff by SCS TR-20 method, UH=SCS, Weighted-CN
Reach routing by Stor-Ind+Trans method - Pond routing by Stor-Ind method

Subcatchment EX-1: Subcat EX-1

Runoff Area=117,882 sf 15.74% Impervious Runoff Depth=5.26"
Flow Length=653' Tc=11.0 min CN=72 Runoff=14.01 cfs 51,675 cf

Subcatchment EX-2: Subcat EX-2

Runoff Area=10,882 sf 75.28% Impervious Runoff Depth=7.80"
Flow Length=154' Tc=6.0 min CN=93 Runoff=2.03 cfs 7,072 cf

Link Dp-1: Analysis Point

Inflow=14.01 cfs 51,675 cf
Primary=14.01 cfs 51,675 cf

Link Dp-2: Analysis Point

Inflow=2.03 cfs 7,072 cf
Primary=2.03 cfs 7,072 cf

Total Runoff Area = 128,764 sf Runoff Volume = 58,746 cf Average Runoff Depth = 5.47"
79.23% Pervious = 102,024 sf 20.77% Impervious = 26,741 sf

**2.3.3 Pre-Development
Full Summary 10 - Year Storm Event**

Time span=0.00-72.00 hrs, dt=0.05 hrs, 1441 points
Runoff by SCS TR-20 method, UH=SCS, Weighted-CN
Reach routing by Stor-Ind+Trans method - Pond routing by Stor-Ind method

Subcatchment EX-1: Subcat EX-1

Runoff Area=117,882 sf 15.74% Impervious Runoff Depth=2.01"
Flow Length=653' Tc=11.0 min CN=72 Runoff=5.29 cfs 19,792 cf

Subcatchment EX-2: Subcat EX-2

Runoff Area=10,882 sf 75.28% Impervious Runoff Depth=3.96"
Flow Length=154' Tc=6.0 min CN=93 Runoff=1.07 cfs 3,593 cf

Link Dp-1: Analysis Point

Inflow=5.29 cfs 19,792 cf
Primary=5.29 cfs 19,792 cf

Link Dp-2: Analysis Point

Inflow=1.07 cfs 3,593 cf
Primary=1.07 cfs 3,593 cf

Total Runoff Area = 128,764 sf Runoff Volume = 23,385 cf Average Runoff Depth = 2.18"
79.23% Pervious = 102,024 sf 20.77% Impervious = 26,741 sf

Summary for Subcatchment EX-1: Subcat EX-1

Runoff = 5.29 cfs @ 12.16 hrs, Volume= 19,792 cf, Depth= 2.01"

Runoff by SCS TR-20 method, UH=SCS, Weighted-CN, Time Span= 0.00-72.00 hrs, dt= 0.05 hrs
 Type III 24-hr 010-YR Rainfall=4.76"

Area (sf)	CN	Description
6,205	61	>75% Grass cover, Good, HSG B
378	74	>75% Grass cover, Good, HSG C
7,305	80	>75% Grass cover, Good, HSG D
193	98	Existing Concrete Pads, HSG D
25	98	Existing Decks and Steps, HSG B
395	98	Existing Decks and Steps, HSG D
227	98	Paved parking, HSG B
14,494	98	Paved parking, HSG D
767	98	Roofs, HSG B
2,447	98	Roofs, HSG D
18,332	55	Woods, Good, HSG B
65,194	70	Woods, Good, HSG C
1,919	77	Woods, Good, HSG D
117,882	72	Weighted Average
99,333		84.26% Pervious Area
18,549		15.74% Impervious Area

Tc (min)	Length (feet)	Slope (ft/ft)	Velocity (ft/sec)	Capacity (cfs)	Description
5.1	64	0.0435	0.21		Sheet Flow, 1A Grass: Short n= 0.150 P2= 3.14"
0.5	35	0.0291	1.28		Sheet Flow, 1B Smooth surfaces n= 0.011 P2= 3.14"
0.3	96	0.0528	4.66		Shallow Concentrated Flow, 2A Paved Kv= 20.3 fps
5.1	458	0.0879	1.48		Shallow Concentrated Flow, 2B Woodland Kv= 5.0 fps
11.0	653	Total			

Subcatchment EX-1: Subcat EX-1

Hydrograph

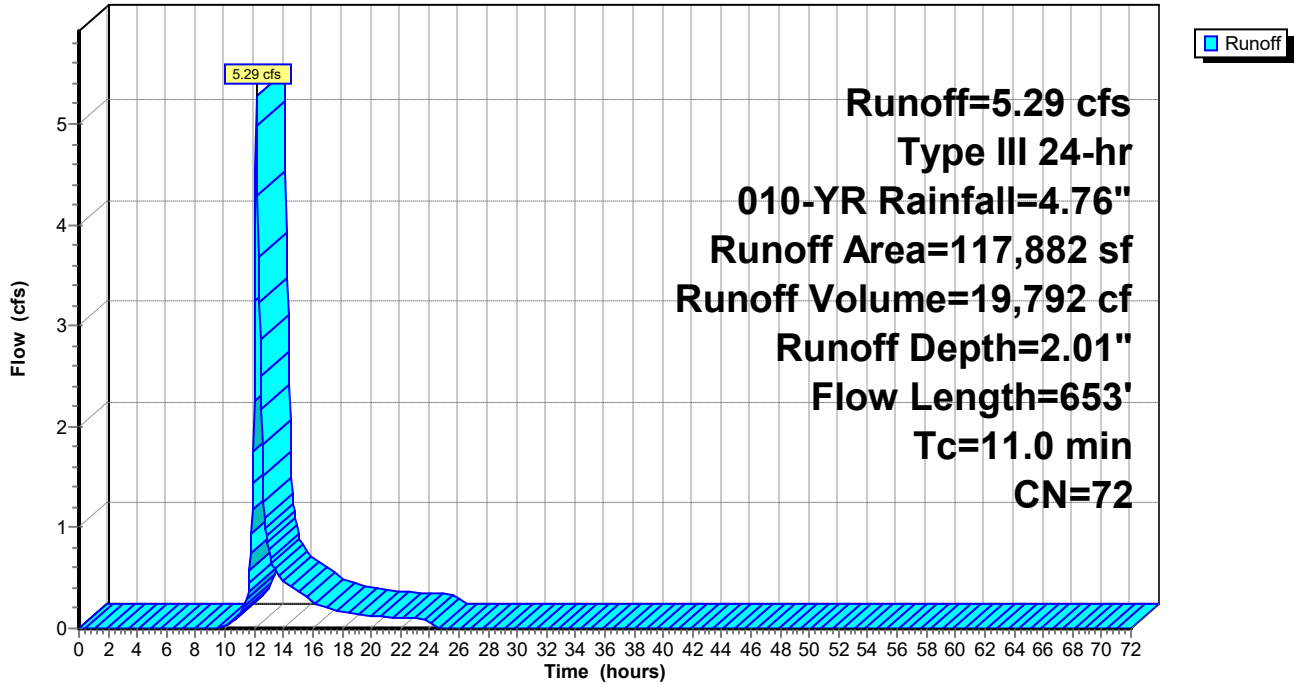

Summary for Subcatchment EX-2: Subcat EX-2

Runoff = 1.07 cfs @ 12.09 hrs, Volume= 3,593 cf, Depth= 3.96"

Runoff by SCS TR-20 method, UH=SCS, Weighted-CN, Time Span= 0.00-72.00 hrs, dt= 0.05 hrs
 Type III 24-hr 010-YR Rainfall=4.76"

Area (sf)	CN	Description
943	74	>75% Grass cover, Good, HSG C
1,747	80	>75% Grass cover, Good, HSG D
508	98	Existing Concrete Pads, HSG C
30	98	Existing Concrete Pads, HSG D
6	98	Existing Decks and Steps, HSG C
97	98	Existing Decks and Steps, HSG D
2,767	98	Paved parking, HSG C
3,498	98	Paved parking, HSG D
1,285	98	Roofs, HSG D
10,882	93	Weighted Average
2,690		24.72% Pervious Area
8,192		75.28% Impervious Area

Tc (min)	Length (feet)	Slope (ft/ft)	Velocity (ft/sec)	Capacity (cfs)	Description
0.8	14	0.2021	0.29		Sheet Flow, 1A Grass: Short n= 0.150 P2= 3.14"
0.6	140	0.0374	3.93		Shallow Concentrated Flow, 2A Paved Kv= 20.3 fps
4.6					Direct Entry, CORRECT TO TR-55 MIN.
6.0	154	Total			

Subcatchment EX-2: Subcat EX-2

Hydrograph

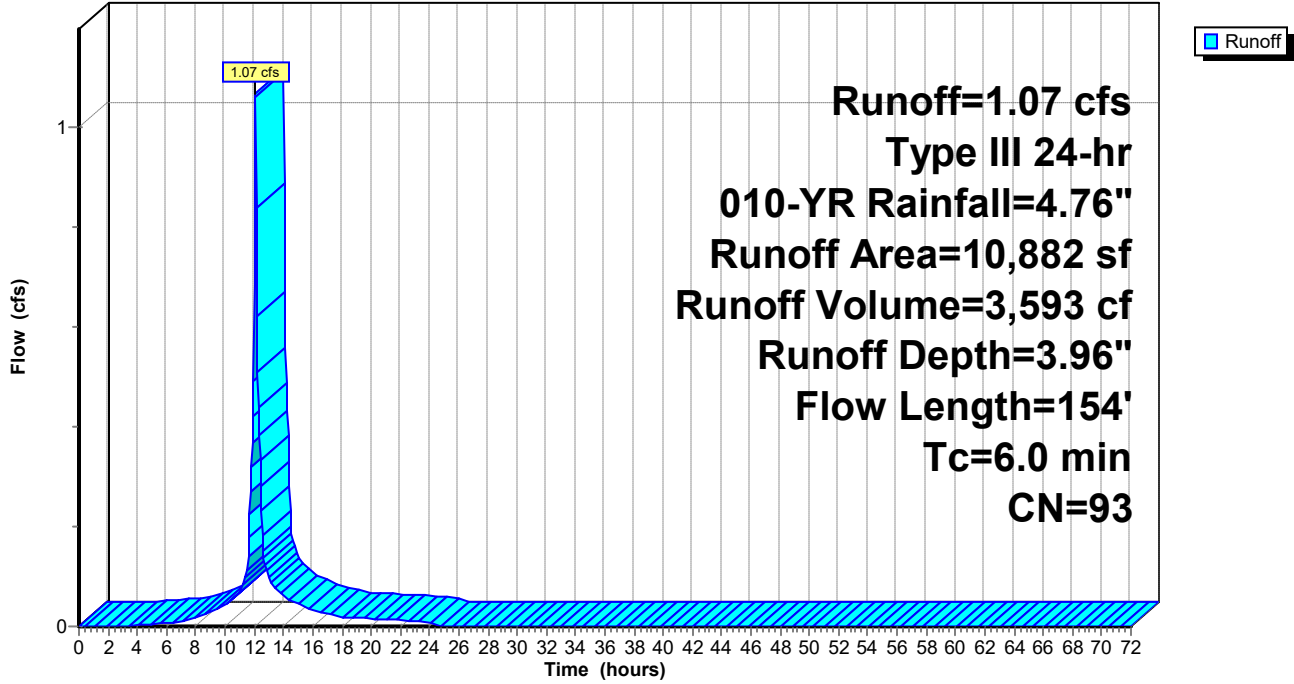

Summary for Link Dp-1: Analysis Point

Inflow Area = 117,882 sf, 15.74% Impervious, Inflow Depth = 2.01" for 010-YR event
Inflow = 5.29 cfs @ 12.16 hrs, Volume= 19,792 cf
Primary = 5.29 cfs @ 12.16 hrs, Volume= 19,792 cf, Atten= 0%, Lag= 0.0 min

Primary outflow = Inflow, Time Span= 0.00-72.00 hrs, dt= 0.05 hrs

Link Dp-1: Analysis Point

Hydrograph

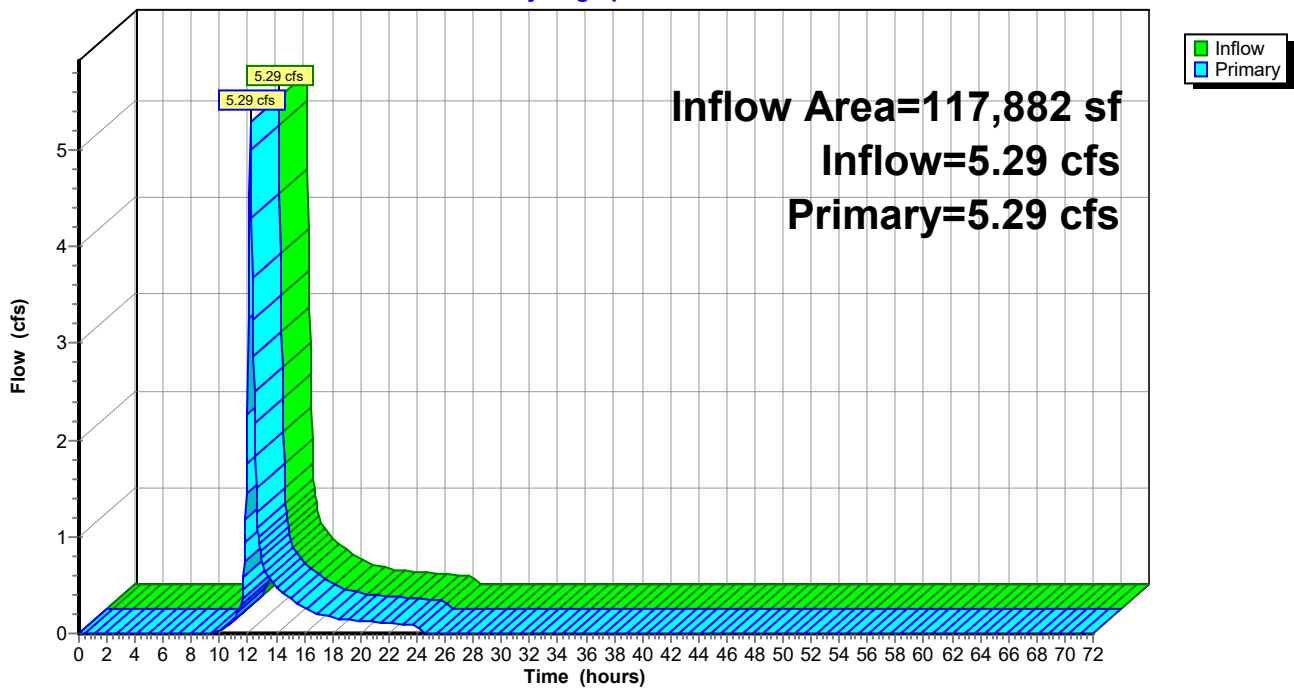

Summary for Link Dp-2: Analysis Point

Inflow Area = 10,882 sf, 75.28% Impervious, Inflow Depth = 3.96" for 010-YR event
Inflow = 1.07 cfs @ 12.09 hrs, Volume= 3,593 cf
Primary = 1.07 cfs @ 12.09 hrs, Volume= 3,593 cf, Atten= 0%, Lag= 0.0 min

Primary outflow = Inflow, Time Span= 0.00-72.00 hrs, dt= 0.05 hrs

Link Dp-2: Analysis Point

Hydrograph

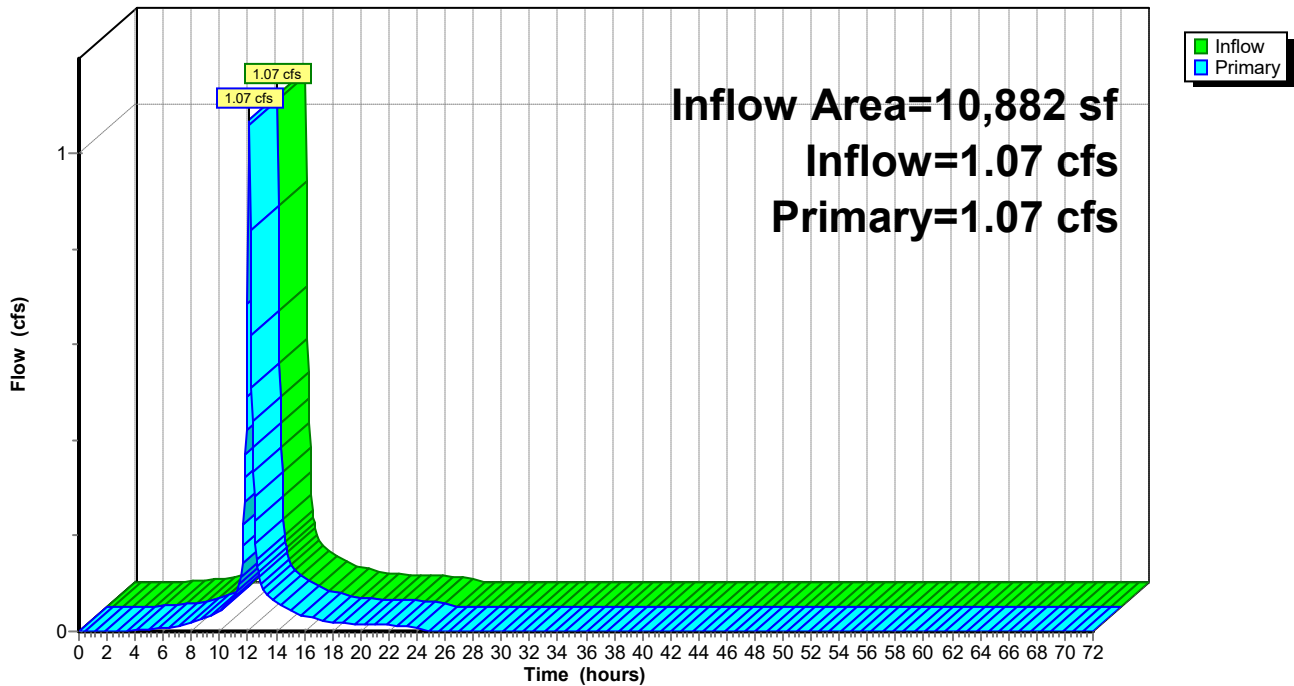

2.4 Post-Development Analysis

2.4 Post-Development Analysis

A post-development analysis covering 129,767 square feet includes the 79,700 square feet of disturbed area within the proposed project site as well as previously developed areas and undisturbed areas. The site has been divided into three post-development subcatchment areas, Subcatchments PR-1 and PR-2 representing the areas draining directly to Drainage Point 1 (Dp-1) and Drainage Point 2 (Dp-2) respectively. PR-1 is modified from the pre-development condition by the reconstruction of the site driveway, resulting in a smaller area draining to Dp-1. PR-2 is smaller than the pre-development equivalent, EX-2, due to the exclusion of areas draining to an underground chamber system. A third subcatchment, PR-3, represents this flow contributing to the underground chamber system, and consists primarily of parking lot areas.

Stormwater from the proposed parking area will be conveyed via sheet flow to grass swale islands which lead to catch basins. These catchbasins then direct stormwater into the isolator row of an underground chamber system under the parking lot. The chamber system has been designed to detain a volume greater than the water quality volume. An overflow structure has been designed to maintain water levels within the profile of the chamber system during events up to the 100-year storm event. Orifices within the overflow structure additionally manage peak flow rates out of the system during storm events.

For more detailed information on the post-developed area, see attached drainage plans found in **Section 4** and the HydroCAD area listing found in **Section 3.4.1**. A pre- versus post-development comparison flow rate table for the 1 inch; 2, 10, 25, 50, and 100 year storm events can be found in **Table 1.0** in **Section 1.1.1**.

2.4.1 Diagram, Area Listing, Soil Listing

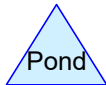
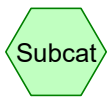
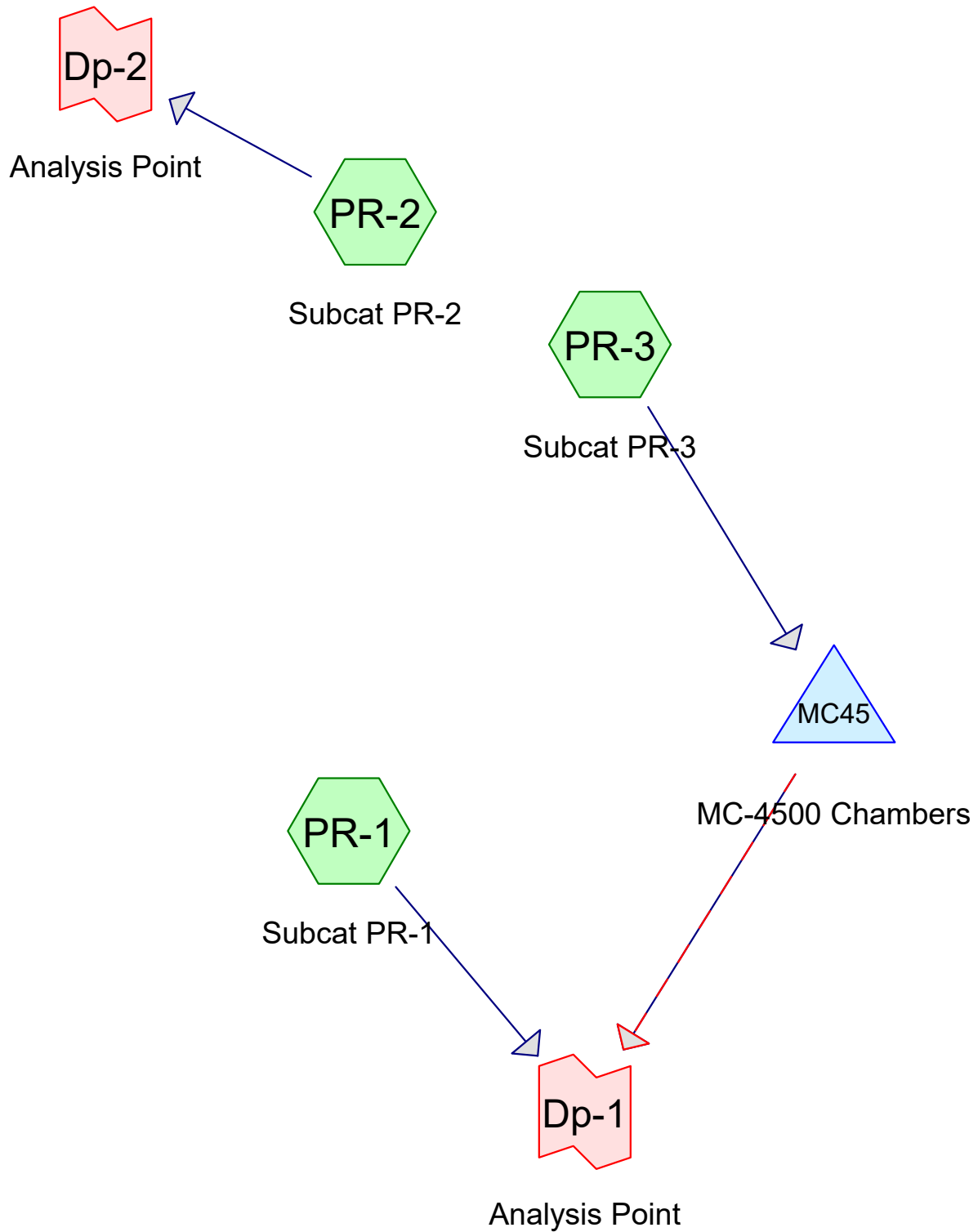

Area Listing (selected nodes)

Area (sq-ft)	CN	Description (subcatchment-numbers)
6,264	61	>75% Grass cover, Good, HSG B (PR-1, PR-3)
10,566	74	>75% Grass cover, Good, HSG C (PR-1, PR-2, PR-3)
10,834	80	>75% Grass cover, Good, HSG D (PR-1, PR-2, PR-3)
40	98	Existing Concrete Pads, HSG B (PR-3)
584	98	Existing Concrete Pads, HSG C (PR-2, PR-3)
3,050	98	Existing Concrete Pads, HSG D (PR-2, PR-3)
6	98	Existing Decks and Steps, HSG C (PR-2)
493	98	Existing Decks and Steps, HSG D (PR-2, PR-3)
17,828	98	Paved parking, HSG B (PR-1, PR-3)
32,163	98	Paved parking, HSG C (PR-1, PR-2, PR-3)
15,386	98	Paved parking, HSG D (PR-2, PR-3)
3,732	98	Roofs, HSG D (PR-2, PR-3)
1,424	55	Woods, Good, HSG B (PR-1, PR-3)
27,003	70	Woods, Good, HSG C (PR-1)
175	77	Woods, Good, HSG D (PR-1, PR-3)

20601_POST-03

Prepared by Horizons Engineering, Inc.
HydroCAD® 10.00-20 s/n 07833 © 2017 HydroCAD Software Solutions LLC

Printed 1/29/2021

Page 3

Soil Listing (selected nodes)

Area (sq-ft)	Soil Group	Subcatchment Numbers
0	HSG A	
25,556	HSG B	PR-1, PR-3
70,322	HSG C	PR-1, PR-2, PR-3
33,671	HSG D	PR-1, PR-2, PR-3
0	Other	

**2.4.2 Post-Development
Node Listing for the 2, 10, 25, 50, and 100 Year Storm Events**

20601_POST-03

Type III 24-hr 1-INCH Rainfall=1.00"

Prepared by Horizons Engineering, Inc.

Printed 1/29/2021

HydroCAD® 10.00-20 s/n 07833 © 2017 HydroCAD Software Solutions LLC

Page 1

Time span=0.00-72.00 hrs, dt=0.05 hrs, 1441 points
Runoff by SCS TR-20 method, UH=SCS, Weighted-CN
Reach routing by Stor-Ind+Trans method - Pond routing by Stor-Ind method

Subcatchment PR-1: Subcat PR-1 Runoff Area=37,822 sf 0.28% Impervious Runoff Depth=0.00"
Flow Length=237' Tc=6.0 min CN=70 Runoff=0.00 cfs 15 cf

Subcatchment PR-2: Subcat PR-2 Runoff Area=9,503 sf 71.13% Impervious Runoff Depth=0.40"
Flow Length=154' Tc=6.0 min CN=92 Runoff=0.10 cfs 319 cf

Subcatchment PR-3: Subcat PR-3 Runoff Area=82,224 sf 80.78% Impervious Runoff Depth=0.45"
Tc=6.0 min CN=93 Runoff=0.97 cfs 3,086 cf

Pond MC45: MC-4500 Chambers Peak Elev=53.51' Storage=1,347 cf Inflow=0.97 cfs 3,086 cf
Discarded=0.08 cfs 3,086 cf Primary=0.00 cfs 0 cf Secondary=0.00 cfs 0 cf Outflow=0.08 cfs 3,086 cf

Link Dp-1: Analysis Point Inflow=0.00 cfs 15 cf
Primary=0.00 cfs 15 cf

Link Dp-2: Analysis Point Inflow=0.10 cfs 319 cf
Primary=0.10 cfs 319 cf

Total Runoff Area = 129,549 sf Runoff Volume = 3,419 cf Average Runoff Depth = 0.32"
43.43% Pervious = 56,266 sf 56.57% Impervious = 73,284 sf

20601_POST-03

Type III 24-hr 002-YR Rainfall=3.14"

Prepared by Horizons Engineering, Inc.

Printed 1/29/2021

HydroCAD® 10.00-20 s/n 07833 © 2017 HydroCAD Software Solutions LLC

Page 2

Time span=0.00-72.00 hrs, dt=0.05 hrs, 1441 points
Runoff by SCS TR-20 method, UH=SCS, Weighted-CN
Reach routing by Stor-Ind+Trans method - Pond routing by Stor-Ind method

Subcatchment PR-1: Subcat PR-1 Runoff Area=37,822 sf 0.28% Impervious Runoff Depth=0.79"
Flow Length=237' Tc=6.0 min CN=70 Runoff=0.71 cfs 2,501 cf

Subcatchment PR-2: Subcat PR-2 Runoff Area=9,503 sf 71.13% Impervious Runoff Depth=2.29"
Flow Length=154' Tc=6.0 min CN=92 Runoff=0.56 cfs 1,816 cf

Subcatchment PR-3: Subcat PR-3 Runoff Area=82,224 sf 80.78% Impervious Runoff Depth=2.39"
Tc=6.0 min CN=93 Runoff=5.01 cfs 16,364 cf

Pond MC45: MC-4500 Chambers Peak Elev=55.50' Storage=6,782 cf Inflow=5.01 cfs 16,364 cf
Discarded=0.11 cfs 10,339 cf Primary=1.64 cfs 6,025 cf Secondary=0.00 cfs 0 cf Outflow=1.75 cfs 16,364 cf

Link Dp-1: Analysis Point Inflow=1.99 cfs 8,526 cf
Primary=1.99 cfs 8,526 cf

Link Dp-2: Analysis Point Inflow=0.56 cfs 1,816 cf
Primary=0.56 cfs 1,816 cf

Total Runoff Area = 129,549 sf Runoff Volume = 20,681 cf Average Runoff Depth = 1.92"
43.43% Pervious = 56,266 sf 56.57% Impervious = 73,284 sf

20601_POST-03

Type III 24-hr 010-YR Rainfall=4.76"

Prepared by Horizons Engineering, Inc.

Printed 1/29/2021

HydroCAD® 10.00-20 s/n 07833 © 2017 HydroCAD Software Solutions LLC

Page 3

Time span=0.00-72.00 hrs, dt=0.05 hrs, 1441 points
Runoff by SCS TR-20 method, UH=SCS, Weighted-CN
Reach routing by Stor-Ind+Trans method - Pond routing by Stor-Ind method

Subcatchment PR-1: Subcat PR-1 Runoff Area=37,822 sf 0.28% Impervious Runoff Depth=1.86"
Flow Length=237' Tc=6.0 min CN=70 Runoff=1.82 cfs 5,863 cf

Subcatchment PR-2: Subcat PR-2 Runoff Area=9,503 sf 71.13% Impervious Runoff Depth=3.86"
Flow Length=154' Tc=6.0 min CN=92 Runoff=0.92 cfs 3,053 cf

Subcatchment PR-3: Subcat PR-3 Runoff Area=82,224 sf 80.78% Impervious Runoff Depth=3.96"
Tc=6.0 min CN=93 Runoff=8.08 cfs 27,150 cf

Pond MC45: MC-4500 Chambers Peak Elev=56.61' Storage=9,550 cf Inflow=8.08 cfs 27,150 cf
Discarded=0.13 cfs 11,562 cf Primary=3.87 cfs 15,589 cf Secondary=0.00 cfs 0 cf Outflow=4.00 cfs 27,150 cf

Link Dp-1: Analysis Point Inflow=5.14 cfs 21,452 cf
Primary=5.14 cfs 21,452 cf

Link Dp-2: Analysis Point Inflow=0.92 cfs 3,053 cf
Primary=0.92 cfs 3,053 cf

Total Runoff Area = 129,549 sf Runoff Volume = 36,067 cf Average Runoff Depth = 3.34"
43.43% Pervious = 56,266 sf 56.57% Impervious = 73,284 sf

20601_POST-03

Type III 24-hr 025-YR Rainfall=6.03"

Prepared by Horizons Engineering, Inc.

Printed 1/29/2021

HydroCAD® 10.00-20 s/n 07833 © 2017 HydroCAD Software Solutions LLC

Page 4

Time span=0.00-72.00 hrs, dt=0.05 hrs, 1441 points
Runoff by SCS TR-20 method, UH=SCS, Weighted-CN
Reach routing by Stor-Ind+Trans method - Pond routing by Stor-Ind method

Subcatchment PR-1: Subcat PR-1 Runoff Area=37,822 sf 0.28% Impervious Runoff Depth=2.83"
Flow Length=237' Tc=6.0 min CN=70 Runoff=2.81 cfs 8,917 cf

Subcatchment PR-2: Subcat PR-2 Runoff Area=9,503 sf 71.13% Impervious Runoff Depth=5.10"
Flow Length=154' Tc=6.0 min CN=92 Runoff=1.19 cfs 4,038 cf

Subcatchment PR-3: Subcat PR-3 Runoff Area=82,224 sf 80.78% Impervious Runoff Depth=5.21"
Tc=6.0 min CN=93 Runoff=10.46 cfs 35,714 cf

Pond MC45: MC-4500 Chambers Peak Elev=57.47' Storage=11,461 cf Inflow=10.46 cfs 35,714 cf
Discarded=0.14 cfs 12,104 cf Primary=5.06 cfs 23,610 cf Secondary=0.00 cfs 0 cf Outflow=5.21 cfs 35,714 cf

Link Dp-1: Analysis Point Inflow=7.16 cfs 32,527 cf
Primary=7.16 cfs 32,527 cf

Link Dp-2: Analysis Point Inflow=1.19 cfs 4,038 cf
Primary=1.19 cfs 4,038 cf

Total Runoff Area = 129,549 sf Runoff Volume = 48,669 cf Average Runoff Depth = 4.51"
43.43% Pervious = 56,266 sf 56.57% Impervious = 73,284 sf

20601_POST-03

Type III 24-hr 050-YR Rainfall=7.22"

Prepared by Horizons Engineering, Inc.

Printed 1/29/2021

HydroCAD® 10.00-20 s/n 07833 © 2017 HydroCAD Software Solutions LLC

Page 5

Time span=0.00-72.00 hrs, dt=0.05 hrs, 1441 points
Runoff by SCS TR-20 method, UH=SCS, Weighted-CN
Reach routing by Stor-Ind+Trans method - Pond routing by Stor-Ind method

Subcatchment PR-1: Subcat PR-1 Runoff Area=37,822 sf 0.28% Impervious Runoff Depth=3.80"
Flow Length=237' Tc=6.0 min CN=70 Runoff=3.79 cfs 11,983 cf

Subcatchment PR-2: Subcat PR-2 Runoff Area=9,503 sf 71.13% Impervious Runoff Depth=6.27"
Flow Length=154' Tc=6.0 min CN=92 Runoff=1.45 cfs 4,967 cf

Subcatchment PR-3: Subcat PR-3 Runoff Area=82,224 sf 80.78% Impervious Runoff Depth=6.39"
Tc=6.0 min CN=93 Runoff=12.67 cfs 43,779 cf

Pond MC45: MC-4500 Chambers Peak Elev=58.39' Storage=13,042 cf Inflow=12.67 cfs 43,779 cf
Discarded=0.16 cfs 12,467 cf Primary=6.07 cfs 31,312 cf Secondary=0.00 cfs 0 cf Outflow=6.23 cfs 43,779 cf

Link Dp-1: Analysis Point Inflow=8.98 cfs 43,295 cf
Primary=8.98 cfs 43,295 cf

Link Dp-2: Analysis Point Inflow=1.45 cfs 4,967 cf
Primary=1.45 cfs 4,967 cf

Total Runoff Area = 129,549 sf Runoff Volume = 60,729 cf Average Runoff Depth = 5.63"
43.43% Pervious = 56,266 sf 56.57% Impervious = 73,284 sf

20601_POST-03

Type III 24-hr 100-YR Rainfall=8.64"

Prepared by Horizons Engineering, Inc.

Printed 1/29/2021

HydroCAD® 10.00-20 s/n 07833 © 2017 HydroCAD Software Solutions LLC

Page 6

Time span=0.00-72.00 hrs, dt=0.05 hrs, 1441 points
Runoff by SCS TR-20 method, UH=SCS, Weighted-CN
Reach routing by Stor-Ind+Trans method - Pond routing by Stor-Ind method

Subcatchment PR-1: Subcat PR-1

Runoff Area=37,822 sf 0.28% Impervious Runoff Depth=5.02"
Flow Length=237' Tc=6.0 min CN=70 Runoff=5.00 cfs 15,819 cf

Subcatchment PR-2: Subcat PR-2

Runoff Area=9,503 sf 71.13% Impervious Runoff Depth=7.68"
Flow Length=154' Tc=6.0 min CN=92 Runoff=1.76 cfs 6,080 cf

Subcatchment PR-3: Subcat PR-3

Runoff Area=82,224 sf 80.78% Impervious Runoff Depth=7.80"
Tc=6.0 min CN=93 Runoff=15.30 cfs 53,432 cf

Pond MC45: MC-4500 Chambers

Peak Elev=59.16' Storage=14,055 cf Inflow=15.30 cfs 53,432 cf

Discarded=0.17 cfs 12,815 cf Primary=10.14 cfs 40,546 cf Secondary=0.24 cfs 71 cf Outflow=10.55 cfs 53,432 cf

Link Dp-1: Analysis Point

Inflow=13.70 cfs 56,436 cf
Primary=13.70 cfs 56,436 cf

Link Dp-2: Analysis Point

Inflow=1.76 cfs 6,080 cf
Primary=1.76 cfs 6,080 cf

Total Runoff Area = 129,549 sf Runoff Volume = 75,332 cf Average Runoff Depth = 6.98"
43.43% Pervious = 56,266 sf 56.57% Impervious = 73,284 sf

**2.4.3 Post-Development
Full Summary 10 - Year Storm Event**

20601_POST-03

Prepared by Horizons Engineering, Inc.
HydroCAD® 10.00-20 s/n 07833 © 2017 HydroCAD Software Solutions LLC

Printed 1/29/2021

Page 1

Pipe Listing (selected nodes)

Line#	Node Number	In-Invert (feet)	Out-Invert (feet)	Length (feet)	Slope (ft/ft)	n	Diam/Width (inches)	Height (inches)	Inside-Fill (inches)
1	MC45	53.60	48.50	72.0	0.0708	0.013	18.0	0.0	0.0
2	MC45	58.50	58.92	21.1	-0.0199	0.013	12.0	0.0	0.0

20601_POST-03

Type III 24-hr 010-YR Rainfall=4.76"

Prepared by Horizons Engineering, Inc.

Printed 1/29/2021

HydroCAD® 10.00-20 s/n 07833 © 2017 HydroCAD Software Solutions LLC

Page 2

Time span=0.00-72.00 hrs, dt=0.05 hrs, 1441 points
Runoff by SCS TR-20 method, UH=SCS, Weighted-CN
Reach routing by Stor-Ind+Trans method - Pond routing by Stor-Ind method

Subcatchment PR-1: Subcat PR-1 Runoff Area=37,822 sf 0.28% Impervious Runoff Depth=1.86"
Flow Length=237' Tc=6.0 min CN=70 Runoff=1.82 cfs 5,863 cf

Subcatchment PR-2: Subcat PR-2 Runoff Area=9,503 sf 71.13% Impervious Runoff Depth=3.86"
Flow Length=154' Tc=6.0 min CN=92 Runoff=0.92 cfs 3,053 cf

Subcatchment PR-3: Subcat PR-3 Runoff Area=82,224 sf 80.78% Impervious Runoff Depth=3.96"
Tc=6.0 min CN=93 Runoff=8.08 cfs 27,150 cf

Pond MC45: MC-4500 Chambers Peak Elev=56.61' Storage=9,550 cf Inflow=8.08 cfs 27,150 cf
Discarded=0.13 cfs 11,562 cf Primary=3.87 cfs 15,589 cf Secondary=0.00 cfs 0 cf Outflow=4.00 cfs 27,150 cf

Link Dp-1: Analysis Point Inflow=5.14 cfs 21,452 cf
Primary=5.14 cfs 21,452 cf

Link Dp-2: Analysis Point Inflow=0.92 cfs 3,053 cf
Primary=0.92 cfs 3,053 cf

Total Runoff Area = 129,549 sf Runoff Volume = 36,067 cf Average Runoff Depth = 3.34"
43.43% Pervious = 56,266 sf 56.57% Impervious = 73,284 sf

Summary for Subcatchment PR-1: Subcat PR-1

Runoff = 1.82 cfs @ 12.10 hrs, Volume= 5,863 cf, Depth= 1.86"

Runoff by SCS TR-20 method, UH=SCS, Weighted-CN, Time Span= 0.00-72.00 hrs, dt= 0.05 hrs
 Type III 24-hr 010-YR Rainfall=4.76"

Area (sf)	CN	Description
2,898	61	>75% Grass cover, Good, HSG B
4,588	74	>75% Grass cover, Good, HSG C
1,661	80	>75% Grass cover, Good, HSG D
7	98	Paved parking, HSG B
98	98	Paved parking, HSG C
1,416	55	Woods, Good, HSG B
27,003	70	Woods, Good, HSG C
151	77	Woods, Good, HSG D
37,822	70	Weighted Average
37,717		99.72% Pervious Area
105		0.28% Impervious Area

Tc (min)	Length (feet)	Slope (ft/ft)	Velocity (ft/sec)	Capacity (cfs)	Description
2.7	36	0.0479	0.22		Sheet Flow, 1A Range n= 0.130 P2= 3.14"
1.8	201	0.1312	1.81		Shallow Concentrated Flow, 2A Woodland Kv= 5.0 fps
1.5					Direct Entry, CORRECT TO TR-55 MIN.
6.0	237	Total			

Subcatchment PR-1: Subcat PR-1

Hydrograph

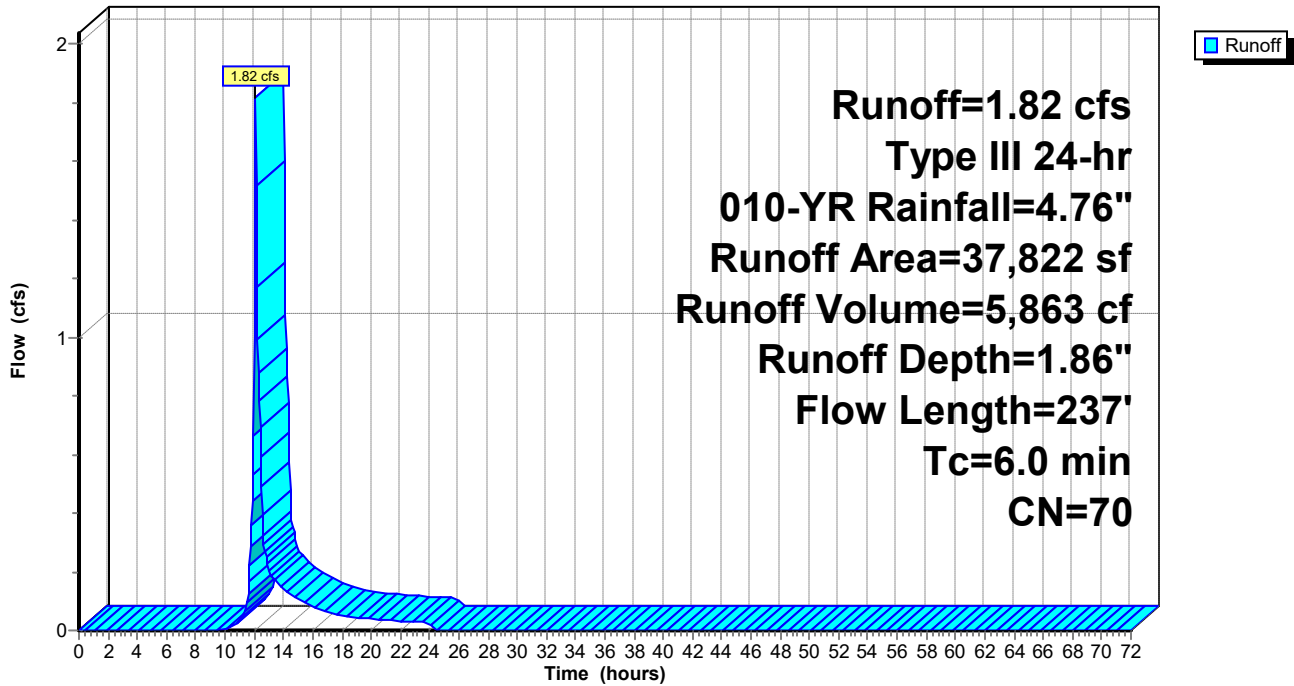

Summary for Subcatchment PR-2: Subcat PR-2

Runoff = 0.92 cfs @ 12.09 hrs, Volume= 3,053 cf, Depth= 3.86"

Runoff by SCS TR-20 method, UH=SCS, Weighted-CN, Time Span= 0.00-72.00 hrs, dt= 0.05 hrs
 Type III 24-hr 010-YR Rainfall=4.76"

Area (sf)	CN	Description
875	74	>75% Grass cover, Good, HSG C
1,869	80	>75% Grass cover, Good, HSG D
584	98	Existing Concrete Pads, HSG C
1,089	98	Existing Concrete Pads, HSG D
6	98	Existing Decks and Steps, HSG C
97	98	Existing Decks and Steps, HSG D
2,759	98	Paved parking, HSG C
1,235	98	Paved parking, HSG D
988	98	Roofs, HSG D
9,503	92	Weighted Average
2,744		28.87% Pervious Area
6,759		71.13% Impervious Area

Tc (min)	Length (feet)	Slope (ft/ft)	Velocity (ft/sec)	Capacity (cfs)	Description
0.8	14	0.2021	0.29		Sheet Flow, 1A Grass: Short n= 0.150 P2= 3.14"
0.6	140	0.0374	3.93		Shallow Concentrated Flow, 2A Paved Kv= 20.3 fps
4.6					Direct Entry, CORRECT TO TR-55 MIN.
6.0	154	Total			

Subcatchment PR-2: Subcat PR-2

Hydrograph

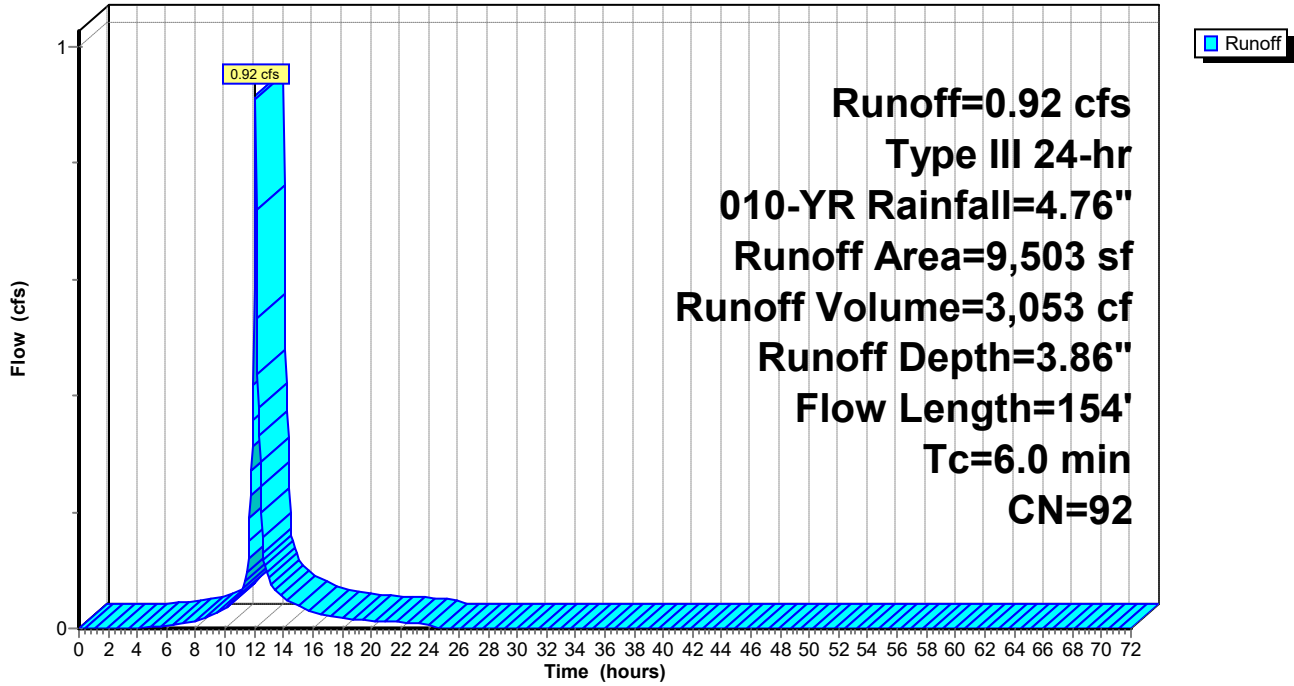

Summary for Subcatchment PR-3: Subcat PR-3

Runoff = 8.08 cfs @ 12.09 hrs, Volume= 27,150 cf, Depth= 3.96"

Runoff by SCS TR-20 method, UH=SCS, Weighted-CN, Time Span= 0.00-72.00 hrs, dt= 0.05 hrs
 Type III 24-hr 010-YR Rainfall=4.76"

Area (sf)	CN	Description
3,365	61	>75% Grass cover, Good, HSG B
5,103	74	>75% Grass cover, Good, HSG C
7,304	80	>75% Grass cover, Good, HSG D
40	98	Existing Concrete Pads, HSG B
0	98	Existing Concrete Pads, HSG C
1,961	98	Existing Concrete Pads, HSG D
395	98	Existing Decks and Steps, HSG D
17,821	98	Paved parking, HSG B
29,306	98	Paved parking, HSG C
14,151	98	Paved parking, HSG D
2,744	98	Roofs, HSG D
8	55	Woods, Good, HSG B
24	77	Woods, Good, HSG D
82,224	93	Weighted Average
15,804		19.22% Pervious Area
66,419		80.78% Impervious Area

Tc (min)	Length (feet)	Slope (ft/ft)	Velocity (ft/sec)	Capacity (cfs)	Description
6.0					Direct Entry, TR-55 MINIMUM

Subcatchment PR-3: Subcat PR-3

Hydrograph

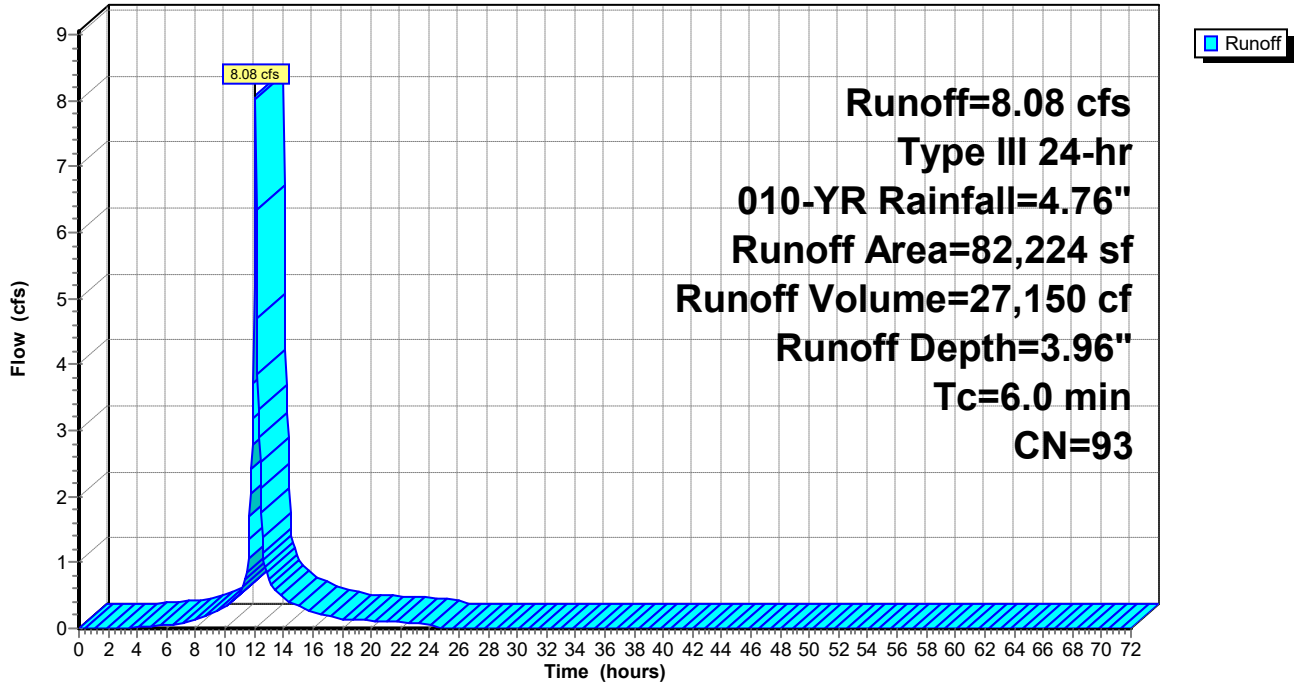

Summary for Pond MC45: MC-4500 Chambers

ADS Stormtech MC4500 chamber system.

Exfiltration rate based on published Ksat value (23.2833um/s) for Hollis-Charlton fine sandy loam, converted to in/hr with a 4X factor of safety applied via discharge multiplier.

Note: Due to program limitations, 80 chambers are included in this model. 81 chambers are depicted on the project plan. This should make the hydraulic model more conservative.

Inflow Area =	82,224 sf, 80.78% Impervious,	Inflow Depth = 3.96"	for 010-YR event
Inflow =	8.08 cfs @ 12.09 hrs,	Volume=	27,150 cf
Outflow =	4.00 cfs @ 12.25 hrs,	Volume=	27,150 cf, Atten= 50%, Lag= 9.5 min
Discarded =	0.13 cfs @ 12.25 hrs,	Volume=	11,562 cf
Primary =	3.87 cfs @ 12.25 hrs,	Volume=	15,589 cf
Secondary =	0.00 cfs @ 0.00 hrs,	Volume=	0 cf

Routing by Stor-Ind method, Time Span= 0.00-72.00 hrs, dt= 0.05 hrs
 Peak Elev= 56.61' @ 12.25 hrs Surf.Area= 3,293 sf Storage= 9,550 cf

Plug-Flow detention time= 260.6 min calculated for 27,150 cf (100% of inflow)
 Center-of-Mass det. time= 260.4 min (1,040.2 - 779.8)

Volume	Invert	Avail.Storage	Storage Description
#1A	52.50'	5,698 cf	37.58'W x 87.62'L x 7.00'H Field A 23,050 cf Overall - 8,805 cf Embedded = 14,246 cf x 40.0% Voids
#2A	53.50'	8,805 cf	ADS_StormTech MC-4500 +Cap x 80 Inside #1 Effective Size= 90.4"W x 60.0"H => 26.46 sf x 4.03'L = 106.5 cf Overall Size= 100.0"W x 60.0"H x 4.33'L with 0.31' Overlap 4 Rows of 20 Chambers Cap Storage= +35.7 cf x 2 x 4 rows = 285.6 cf
		14,503 cf	Total Available Storage

Storage Group A created with Chamber Wizard

Device	Routing	Invert	Outlet Devices
#1	Discarded	52.50'	3.300 in/hr Exfiltration X 0.25 over Horizontal area Conductivity to Groundwater Elevation = 48.67' Phase-In= 0.05'
#2	Device 5	54.95'	20.0" W x 4.0" H Vert. Low Orifice 4"HX20"W C= 0.600
#3	Device 5	55.95'	12.0" W x 2.0" H Vert. Medium Flow 2"Hx12"W C= 0.600
#4	Device 5	58.85'	6.0' long Sharp-Crested Rectangular Weir 2 End Contraction(s)
#5	Primary	53.60'	18.0" Round 18" HDPE outlet L= 72.0' CPP, square edge headwall, Ke= 0.500 Inlet / Outlet Invert= 53.60' / 48.50' S= 0.0708 '/' Cc= 0.900 n= 0.013 Corrugated PE, smooth interior, Flow Area= 1.77 sf
#6	Secondary	58.92'	12.0" Round 12" BYPASS L= 21.1' CPP, square edge headwall, Ke= 0.500 Inlet / Outlet Invert= 58.50' / 58.92' S= -0.0199 '/' Cc= 0.900 n= 0.013 Corrugated PE, smooth interior, Flow Area= 0.79 sf

20601_POST-03

Prepared by Horizons Engineering, Inc.

HydroCAD® 10.00-20 s/n 07833 © 2017 HydroCAD Software Solutions LLC

Type III 24-hr 010-YR Rainfall=4.76"

Printed 1/29/2021

Page 10

Discarded OutFlow Max=0.13 cfs @ 12.25 hrs HW=56.60' (Free Discharge)

↑1=Exfiltration (Controls 0.13 cfs)

Primary OutFlow Max=3.87 cfs @ 12.25 hrs HW=56.60' (Free Discharge)

↑5=18" HDPE outlet (Passes 3.87 cfs of 12.78 cfs potential flow)

↑2=Low Orifice 4"HX20"W (Orifice Controls 3.26 cfs @ 5.87 fps)

↑3=Medium Flow 2"Hx12"W (Orifice Controls 0.61 cfs @ 3.64 fps)

↑4=Sharp-Crested Rectangular Weir (Controls 0.00 cfs)

Secondary OutFlow Max=0.00 cfs @ 0.00 hrs HW=52.50' (Free Discharge)

↑6=12" BYPASS (Controls 0.00 cfs)

Pond MC45: MC-4500 Chambers - Chamber Wizard Field A

Chamber Model = ADS_StormTech MC-4500 +Cap (ADS StormTech® MC-4500 with cap volume)

Effective Size= 90.4"W x 60.0"H => 26.46 sf x 4.03'L = 106.5 cf

Overall Size= 100.0"W x 60.0"H x 4.33'L with 0.31' Overlap

Cap Storage= +35.7 cf x 2 x 4 rows = 285.6 cf

100.0" Wide + 9.0" Spacing = 109.0" C-C Row Spacing

20 Chambers/Row x 4.02' Long +2.56' Cap Length x 2 = 85.62' Row Length +12.0" End Stone x 2 = 87.62' Base Length

4 Rows x 100.0" Wide + 9.0" Spacing x 3 + 12.0" Side Stone x 2 = 37.58' Base Width

12.0" Base + 60.0" Chamber Height + 12.0" Cover = 7.00' Field Height

80 Chambers x 106.5 cf + 35.7 cf Cap Volume x 2 x 4 Rows = 8,804.8 cf Chamber Storage

23,050.5 cf Field - 8,804.8 cf Chambers = 14,245.7 cf Stone x 40.0% Voids = 5,698.3 cf Stone Storage

Chamber Storage + Stone Storage = 14,503.1 cf = 0.333 af

Overall Storage Efficiency = 62.9%

Overall System Size = 87.62' x 37.58' x 7.00'

80 Chambers

853.7 cy Field

527.6 cy Stone

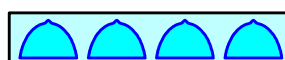
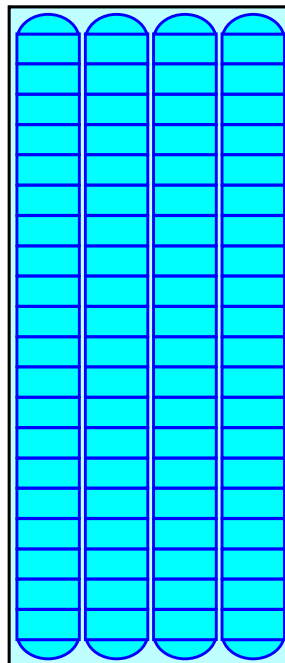

Pond MC45: MC-4500 Chambers

Hydrograph

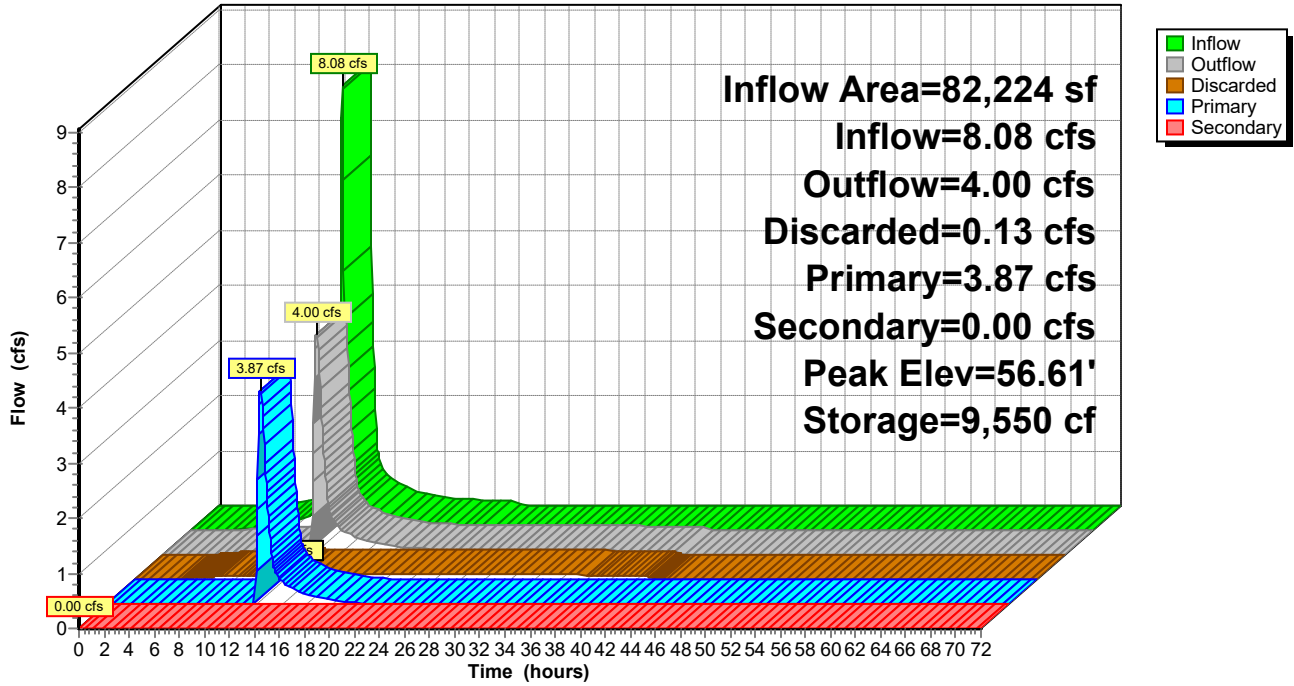

Summary for Link Dp-1: Analysis Point

Inflow Area = 120,046 sf, 55.42% Impervious, Inflow Depth = 2.14" for 010-YR event
Inflow = 5.14 cfs @ 12.16 hrs, Volume= 21,452 cf
Primary = 5.14 cfs @ 12.16 hrs, Volume= 21,452 cf, Atten= 0%, Lag= 0.0 min

Primary outflow = Inflow, Time Span= 0.00-72.00 hrs, dt= 0.05 hrs

Link Dp-1: Analysis Point

Hydrograph

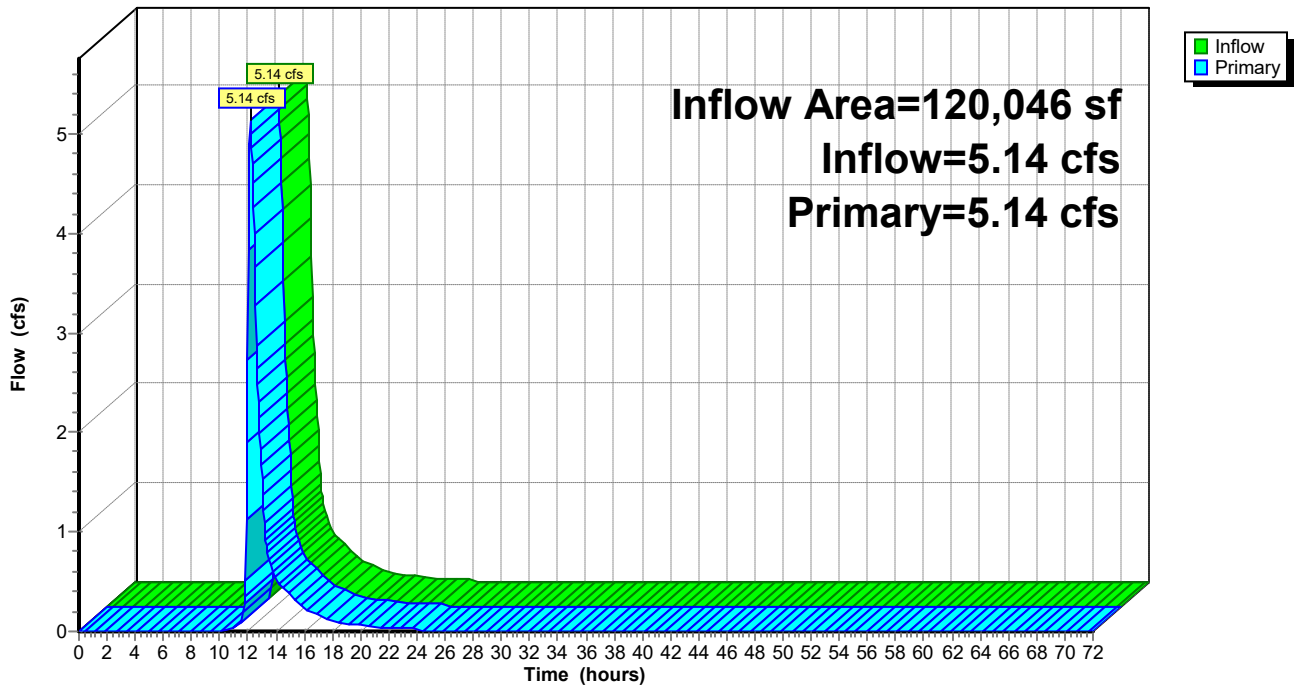

Summary for Link Dp-2: Analysis Point

Inflow Area = 9,503 sf, 71.13% Impervious, Inflow Depth = 3.86" for 010-YR event
Inflow = 0.92 cfs @ 12.09 hrs, Volume= 3,053 cf
Primary = 0.92 cfs @ 12.09 hrs, Volume= 3,053 cf, Atten= 0%, Lag= 0.0 min

Primary outflow = Inflow, Time Span= 0.00-72.00 hrs, dt= 0.05 hrs

Link Dp-2: Analysis Point

Hydrograph

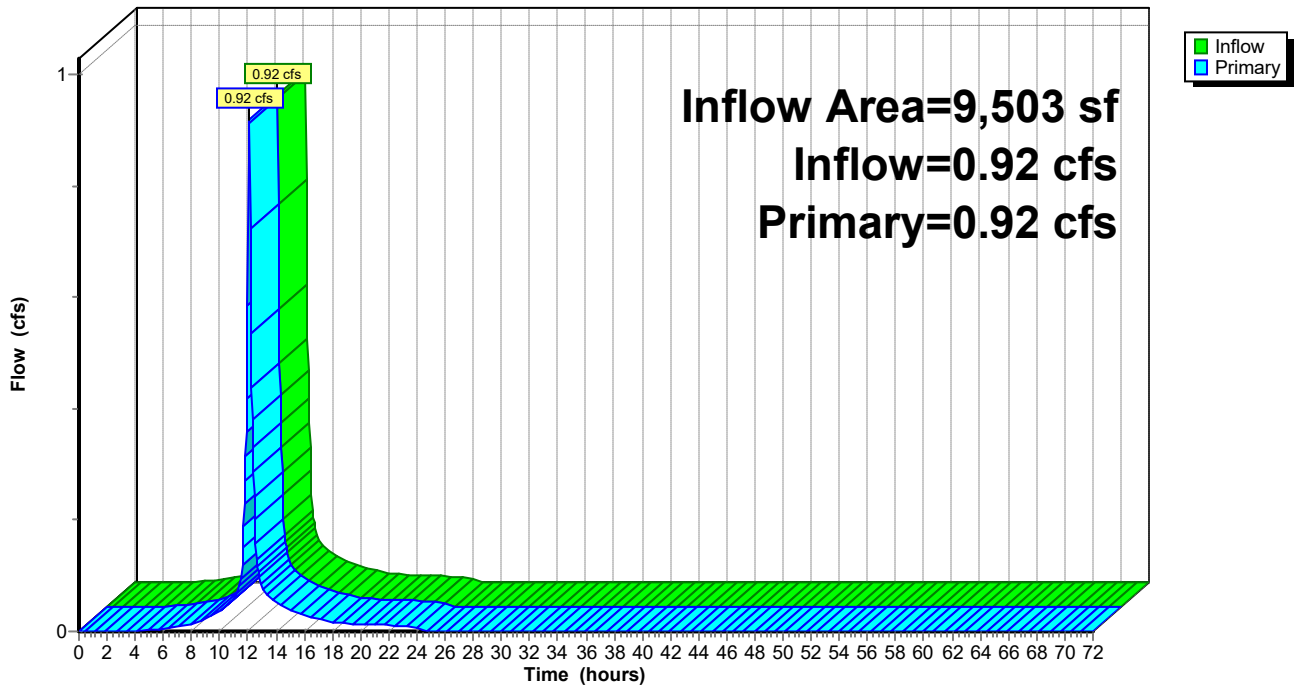

2.5 Stone Riprap Calculations (Energy Dissipation – Stability Calculations)

Culvert Report

P-300

Invert Elev Dn (ft)	= 48.50
Pipe Length (ft)	= 70.20
Slope (%)	= 7.26
Invert Elev Up (ft)	= 53.60
Rise (in)	= 24.0
Shape	= Circular
Span (in)	= 24.0
No. Barrels	= 1
n-Value	= 0.012
Culvert Type	= Circular Concrete
Culvert Entrance	= Square edge w/headwall (C)
Coeff. K,M,c,Y,k	= 0.0098, 2, 0.0398, 0.67, 0.5

Embankment

Top Elevation (ft)	= 61.80
Top Width (ft)	= 6.30
Crest Width (ft)	= 10.00

Calculations

Qmin (cfs)	= 5.06
Qmax (cfs)	= 5.06
Tailwater Elev (ft)	= (dc+D)/2

Highlighted

Qtotal (cfs)	= 5.06
Qpipe (cfs)	= 5.06
Qovertop (cfs)	= 0.00
Veloc Dn (ft/s)	= 2.16
Veloc Up (ft/s)	= 4.37
HGL Dn (ft)	= 49.90
HGL Up (ft)	= 54.39
Hw Elev (ft)	= 54.64
Hw/D (ft)	= 0.52
Flow Regime	= Inlet Control

$$\text{DEPTH} = \text{HGLdn} - \text{INVdn}$$
$$\text{DEPTH} = 49.90 - 48.50$$
$$\text{DEPTH} = 1.40 \text{ FT}$$

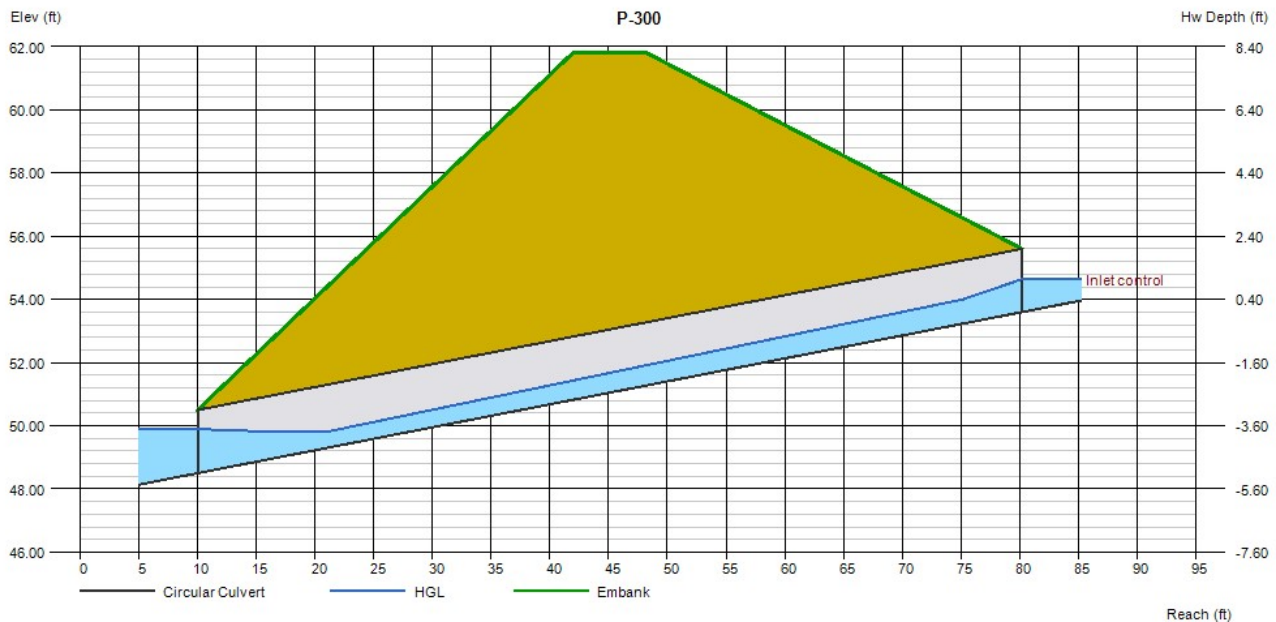

2.6 Site Specific Soil Survey

Soils included on Existing Conditions plan sheet

2.7 Inspection and Maintenance Manual

Frequency of Activities

The best time to perform inspections is during the onset of rain. To the extent practicable inspections should be timed to coincide with moderate storms that do not have the potential for severe (thunderstorms, etc.) precipitation. The frequency of inspection and maintenance will vary by intensity of use; however the recommended inspection frequency for each feature has been described in the protocol sheets to follow.

Maintenance frequencies will be determined based upon the results of the inspections and if specific maintenance thresholds are observed to have been crossed during inspections.

Records

A record of inspection and maintenance activities shall be recorded on the Inspection and Maintenance Log presented following. Records of Inspection and Maintenance Logs shall be made available upon request.

Control of Invasive Plants

Invasive plants are introduced, alien, or non-native plants, which have been moved by people from their native habitat to a new area. Some exotic plants are imported for human use such as landscaping, erosion control, or food crops. They also can arrive as "hitchhikers" among shipments of other plants, seeds, packing materials, or fresh produce. Some exotic plants become invasive and cause harm by:

- becoming weedy and overgrown;
- killing established shade trees;
- obstructing pipes and drainage systems;
- forming dense beds in water;
- lowering water levels in lakes, streams, and wetlands;
- destroying natural communities;
- promoting erosion on stream banks and hillsides; and
- resisting control except by hazardous chemical.

During maintenance activities, check for the presence of invasive plants and remove in a safe manner as described on the following pages. They should be controlled as described on the following pages.

CB- CATCH BASINS

(To include trench drains, drain manholes, and double catchbasins, and drop inlets)



Inspection Frequency:

Inspect 2 times per year (spring and fall-after leaf drop) unless otherwise described- maintain features as described below.

Maintenance Requirements:

- Remove debris from inlets grates.
- If an oily sheen or hydrocarbons are present on the water surface contact your supervisor
 - Skimming/absorbants should be used to remove to the material and disposed of in accordance with state and federal regulations.
- Remove accumulated sediment in sump if sediment has accumulated to ½ sump depth or is within 1 foot below invert out of basin.
 - If sediment has accumulated to pipe invert out, check discharge end of pipe for sediment accumulations and remove sediment from pipe.
 - Note such conditions and increase inspection frequency if it is determined that the loads of sediment to the basin are consistently high.
 - Address source of sediment if possible.
- For drop inlets with no sump sediments will typically only accumulate if there is an obstruction in the downstream culvert and/or culvert outlet. Therefore where sediments are present in structure:
 - Inspect culvert and culvert outlet and remove debris and sediments.
- Do not dispose of catch basin cleanings in wetland areas or within 40 feet of wetland areas- refer to Appendix b; pages B-2 and B-4 in NH DES guidance document http://des.nh.gov/organization/divisions/water/stormwater/documents/nh_idde_sop.pdf to determine where catchbasin cleanings and street sweepings may be disposed of.

GS-GRASS SWALES

(Includes grass ditches, grass Pre-Treatment Swales, and grass Treatment Swales)



Inspection Frequency:

Inspect once per year unless otherwise described.

Grassed channels should be inspected for sediment accumulation, vegetation loss, and presence of invasive species. Maintain features as described below.

Maintenance Requirements:

- Repairs, including vegetation replacement, should be made based on inspection.
 - Grass Treatment Swales require a relatively flat swale floor (both laterally (side to side), and longitudinally (along their length)) to spread water across the swale floor and slow flows down to enable sediments to settle in the swale. This may create areas of standing water and associated dead spots in the grass.
 - Reseed such areas by scratching in seed and applying mulch matting for areas that exceed 4 ft. in diameter.
 - If reseeding does not work or water is seen ponding for more than 48 hours turf aeration of the swale floor may rejuvenate it.
 - Re-seed and rake out plugs created by aeration activities.
- Remove sediment and debris annually, or more frequently as warranted by inspection.
 - Leaves should be raked from swales to avoid smothering grass.
- Mow vegetated channels at least once a year to control establishment of woody vegetation.
 - It is recommended to cut grass no shorter than 4 inches.
 - Rake/collect grass clippings from swales.

RR- RIP RAP OUTLET APRONS
(To include Rip Rap Channels/Swales)



Inspection Frequency:

Inspect once per year unless otherwise indicated or if apron is inlet to a stormwater Detention/treatment Pond or Bioretention Area (if so, see DP and BR, respectively). Maintain features as described below.

Maintenance Requirements:

- Remove debris accumulations if they redirect flow off of the apron or otherwise restrict flow or cause any backflow into the culvert outlet.
- Repair and replace gaps in stone coverage with stone of similar or larger size stone.
 - Refer to design plans for apron dimensions, stone size and any required geotextile underlayment.
 - Be careful not to extend apron into jurisdictional wetland areas or local wetland buffers.
- Ensure that any flared end sections are level to help spread water out onto apron. Re-level if needed.
- Ensure concrete or masonry headwalls are not undermined or have evidence of piping/voids; evidence that flow has bypassed culvert. If voids are found:
 - Check again during storms to determine what has caused voids and contact an engineer if water is flowing around/bypassing culvert.

ST- STORMTECH INFILTRATION CHAMBERS (To include stormtech isolator rows)



Photo Credit: Stormtech

Inspection Frequency:

Isolator Rows shall be inspected immediately after completion of the site construction and cleaned out if necessary. The typical inspection schedule after construction for the Isolator Rows is a minimum of twice a year (spring & fall) - maintain features as described below.

Inspection of the Isolator Row shall involve a visual check using either the inspection ports or the access manholes

Maintenance Requirements:

- If upon visual inspection of the Isolator Row, it is found that sediment has accumulated to an average depth exceeding 3 inches throughout the length of the Isolator Row, cleanout is required.
- Cleanout of the accumulated material in the Isolator Row should be accomplished by vacuum pumping.
- Cleanout should be performed during dry weather and care should be taken to avoid tearing the fabric in the Isolator Rows.
- A site maintenance log will be kept. This log will record the dates when maintenance tasks were completed, the person who completed the task, and any observations of malfunctions in components of the stormwater management system. Call 1-888-892-2694 to speak with a Technical representative or visit www.stormtech.com.

2.8 References
Preparer's Certification
Reviewer's Certification

REFERENCES

- Mays, Larry. *Stormwater Collection Systems Design Handbook*. McGraw-Hill. New York, NY. 2001
- McCarthy, David. *Essentials of Soil Mechanics and Foundations: Sixth Edition*. Prentice Hall. Columbus, Ohio. 2002.
- NHDES. *New Hampshire Stormwater Manual*. New Hampshire Department of Environmental Services. 2008.
- NHDES. *New Hampshire Homeowner's Guide to Stormwater Management*. New Hampshire Department of Environmental Services. 2012
- The UNH Stormwater Center, *The LID Stormwater Management Systems Demonstrate LID Stormwater Management Systems Demonstrate Superior Cold Climate Performance than Superior Cold Climate Performance than Conventional Stormwater Management Systems.*
UNH Stormwater Center, NEIWPC 2007 NPS Conference, Newport, RI, May 2007

PREPARER'S CERTIFICATION



Prepared by Chris Hernick, P.E.

SECTION 3.0 – PLANS

3.1 Design Plans

(Unbound)

**This Section Left Intentionally Blank
(Plans Bound Separately)**

3.2 Wetlands Plan

This Section Left Intentionally Blank
Wetlands included on Existing Conditions plan sheet



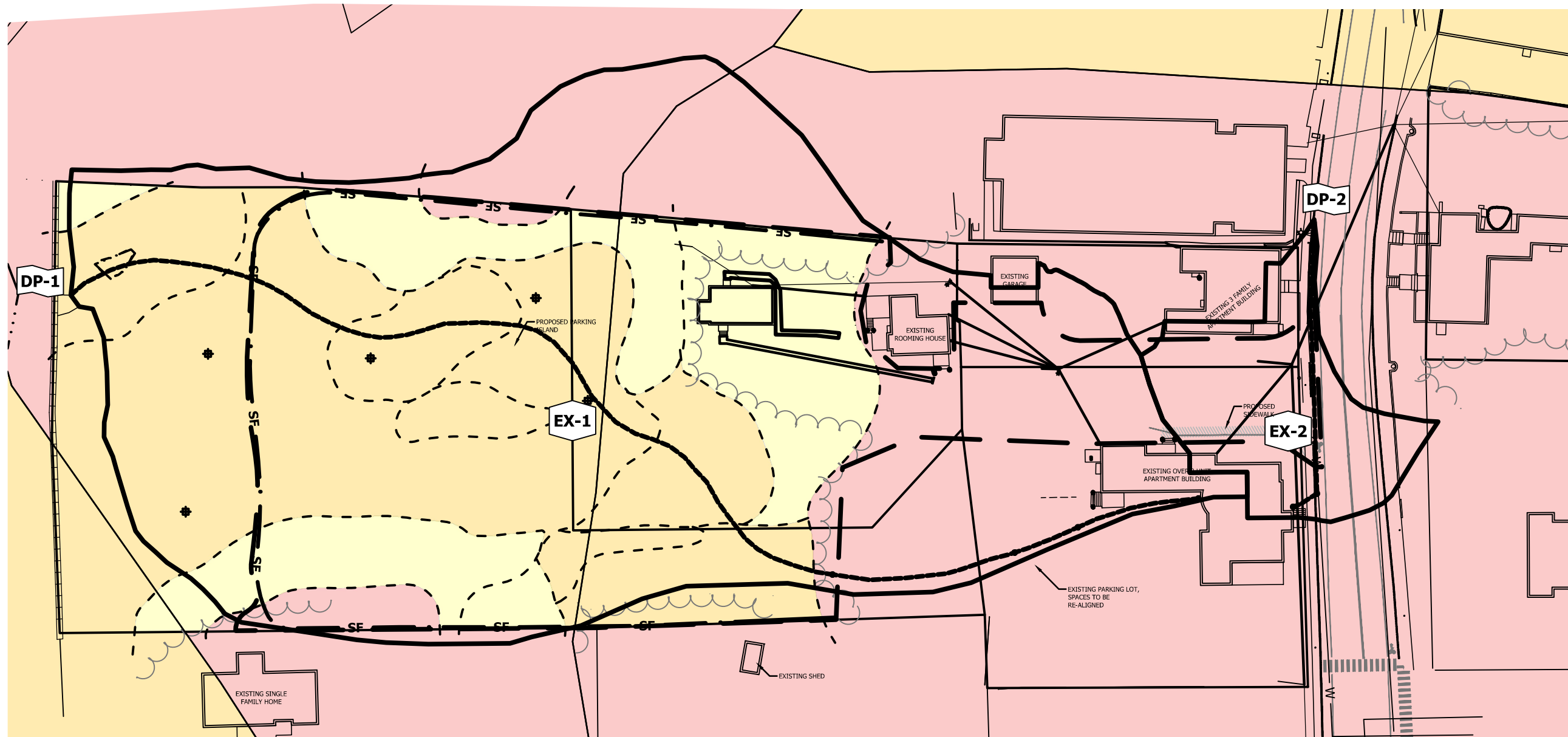



3.3 Color Coded Hydrologic Soils Group Plans

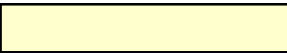

GRAPHIC SCALE

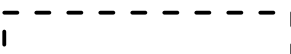

(IN FEET)
1 inch = 60 ft.

- | | | | |
|---|----------------|---|------------------------|
|  | HSG B |  | DRAINAGE AREA BOUNDARY |
|  | HSG C |  | DRAINAGE PATH |
|  | HSG D |  | SOILS AREA BOUNDARY |
|  | DRAINAGE AREA | | |
|  | ANALYSIS POINT | | |

DATE: 10/28/20
SCALE: 1"=60'
DESIGNED BY:
DRAWN BY: C&H
APPROVED BY:
DWG FILE: 20601 CONCEPT 008.dwg

PRE-DEVELOPMENT
COLOR-CODED SOIL PLAN
prepared for
TOOMERFS, LLC
TAX MAP 5, LOTS 1-9 AND 1-10
19 MAIN ST AND 21 MAIN ST DURHAM, NH

MJS ENGINEERING, P.C.
CIVIL • STRUCTURAL • ENVIRONMENTAL
5 RAILROAD ST., P. O. BOX 359
NEWMARKET, NH 03857
PHONE: (603) 659-4979, FAX: (603) 659-4627
E-MAIL: MJS@MJS-ENGINEERING.COM

JOB: 18-041

C3.3.1

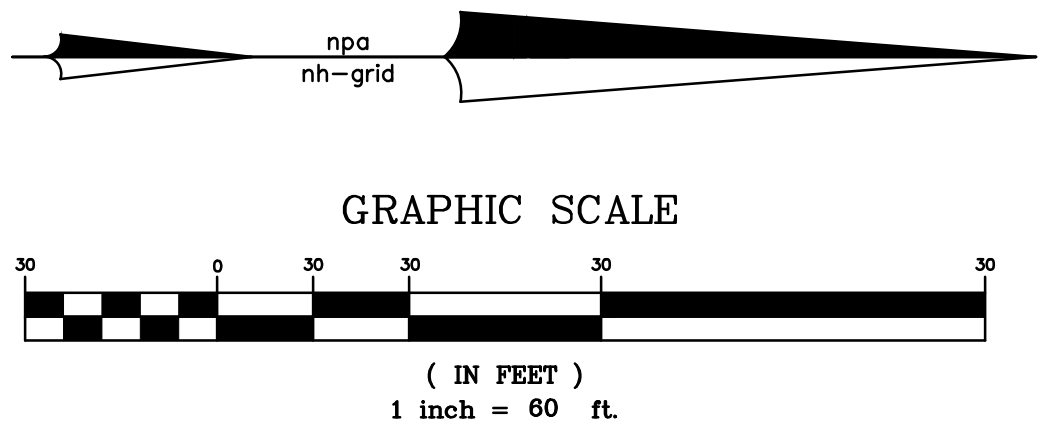
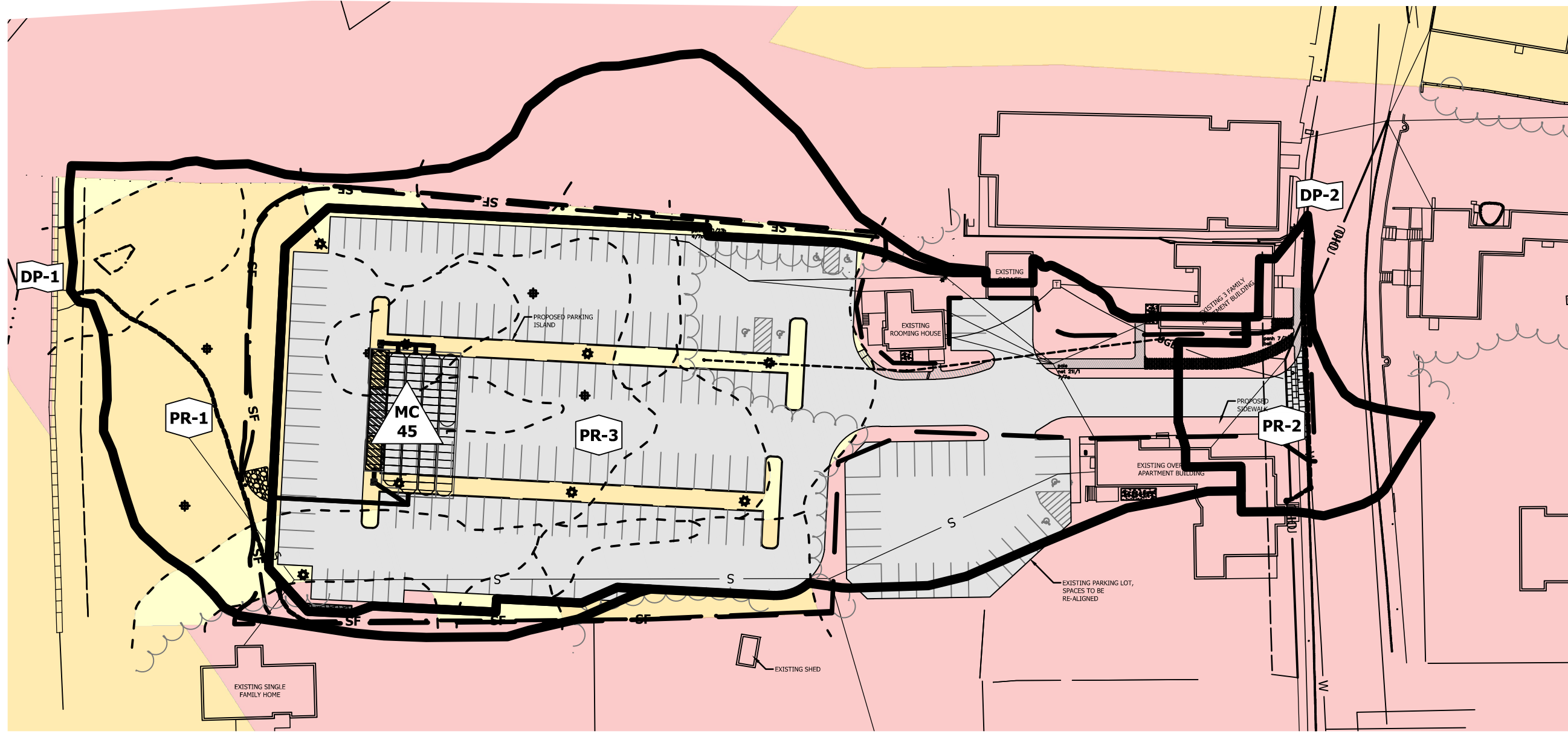

- HSG B
- HSG C
- HSG D
- DRAINAGE AREA BOUNDARY
- DRAINAGE PATH
- SOILS AREA BOUNDARY
- PR-2 DRAINAGE AREA
- MC 45 TREATMENT SYSTEM
- DP-1 ANALYSIS POINT

DATE: 10/28/20
 SCALE: 1"=60'
 DESIGNED BY:
 DRAWN BY: C&H
 APPROVED BY:
 DWG FILE: 20601 CONCEPT 008.dwg

POST-DEVELOPMENT
 COLOR-CODED SOIL PLAN
 prepared for
 TOOMERFS, LLC
 TAX MAP 5, LOTS 1-9 AND 1-10
 19 MAIN ST AND 21 MAIN ST DURHAM, NH

MJS ENGINEERING, P.C.
 CIVIL • STRUCTURAL • ENVIRONMENTAL
 5 RAILROAD ST., P. O. BOX 359
 NEWARKET, NH 03857
 PHONE: (603) 659-4979, FAX: (603) 659-4627
 E-MAIL: MJS@MJS-ENGINEERING.COM

JOB: 18-041
 C3.3.2

3.4 Pre- & Post-Development Drainage Area Plans

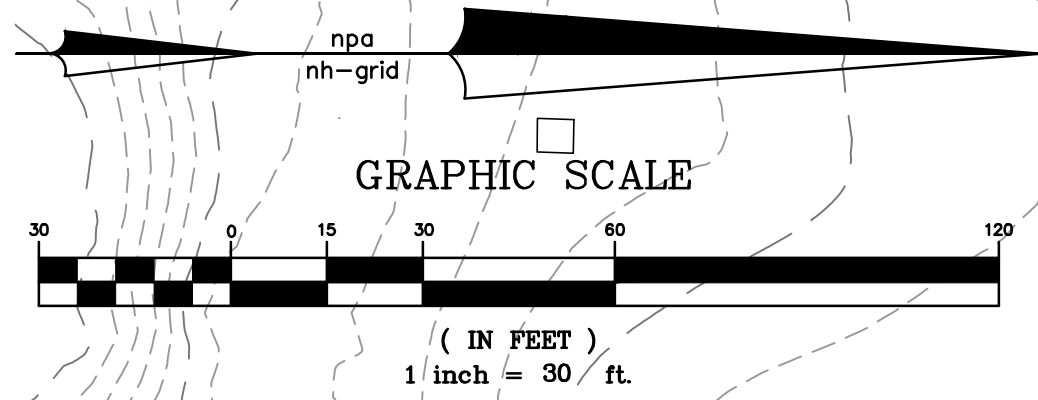
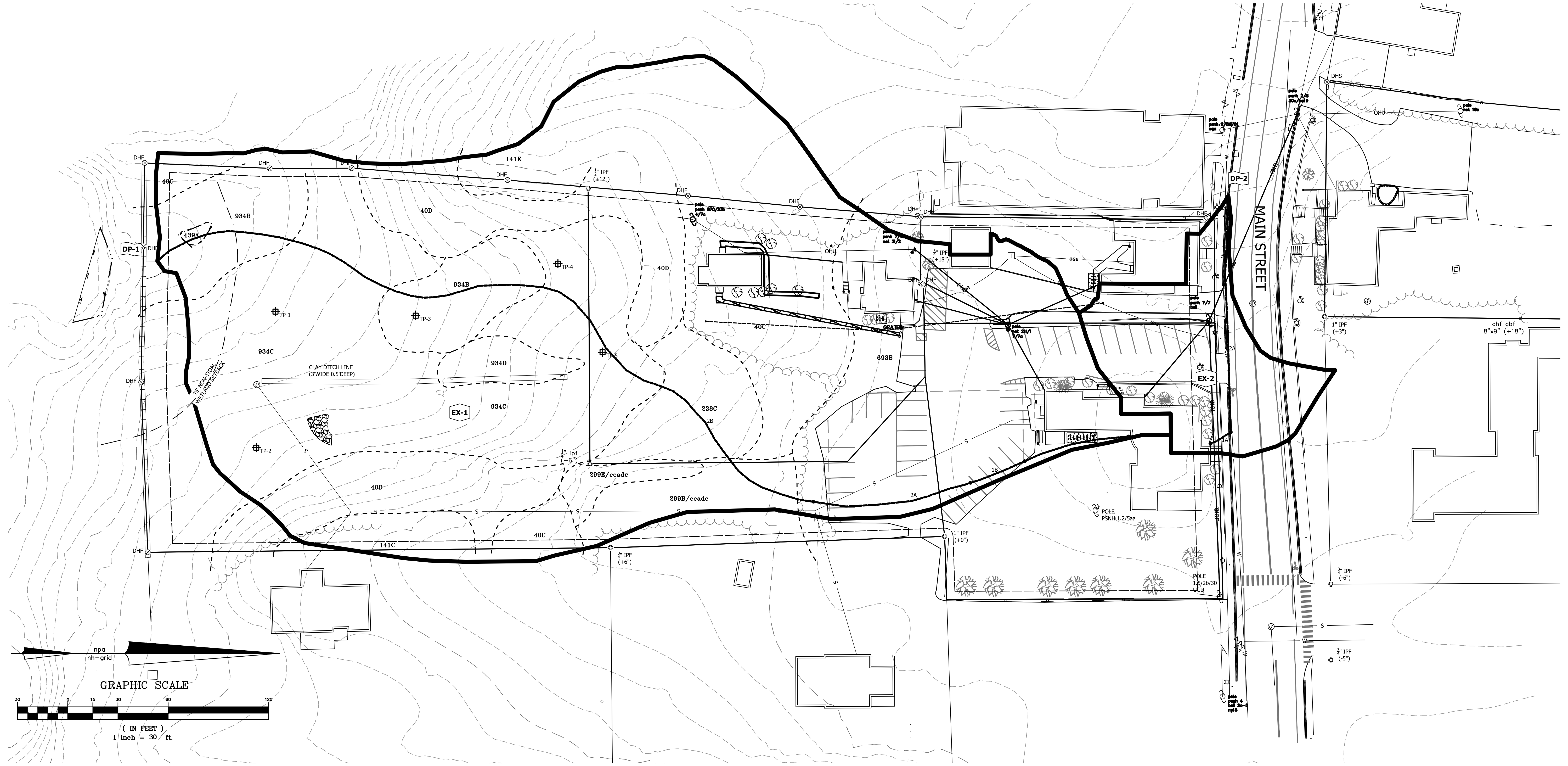

LEGEND

- DRAINAGE AREA
- ANALYSIS POINT
- DRAINAGE AREA BOUNDARY
- DRAINAGE PATH
- SOILS AREA BOUNDARY
- EXISTING BUILDING
- EXISTING DECK/STEPS
- EXISTING CONCRETE PAD
- EXISTING PAVEMENT/PARKING

AREA WITHIN WATERSHED	
EXISTING BUILDING	4,499 SF
EXISTING DECK/STEPS	524 SF
EXISTING CONCRETE PAD	731 SF

	TOTAL AREA:	117,882 SF
	IMPERVIOUS COVER:	15.74%
	TIME OF CONCENTRATION:	11.0 MIN
	TOTAL AREA:	10,882 SF
	IMPERVIOUS COVER:	75.28%
	TIME OF CONCENTRATION:	6.0* MIN

*CALCULATION METHOD MINIMAL TIME

NO.	REVISIONS	DATE	INT.

DATE: 9/26/18
 SCALE: 1"=50'
 DESIGNED BY:
 DRAWN BY:
 APPROVED BY:
 DWG FILE: 20601 CONCEPT 008.dwg

PRE-DEVELOPMENT DRAINAGE
 prepared for
 TOOMERFS, LLC
 TAX MAP 5, LOTS 1-9 AND 1-10
 19 MAIN ST AND 21 MAIN ST DURHAM, NH

MJS ENGINEERING, P.C.
 CIVIL • STRUCTURAL • ENVIRONMENTAL
 5 HALLAMSD ST., SUITE 309
 DURHAM, NH 03824
 PHONE: (603) 659-6979, FAX: (603) 659-6627
 E-MAIL: MJS@MJE-ENGINEERING.COM

JOB: 18-041
 PRE

Drawing Name: C:\Users\Chidster\Desktop\20601 M.S. - 19-21 Main St\DWG\Concepts\20601 CONCEPT 008.dwg
 Mon, 01 Feb 2021 - 9:05am

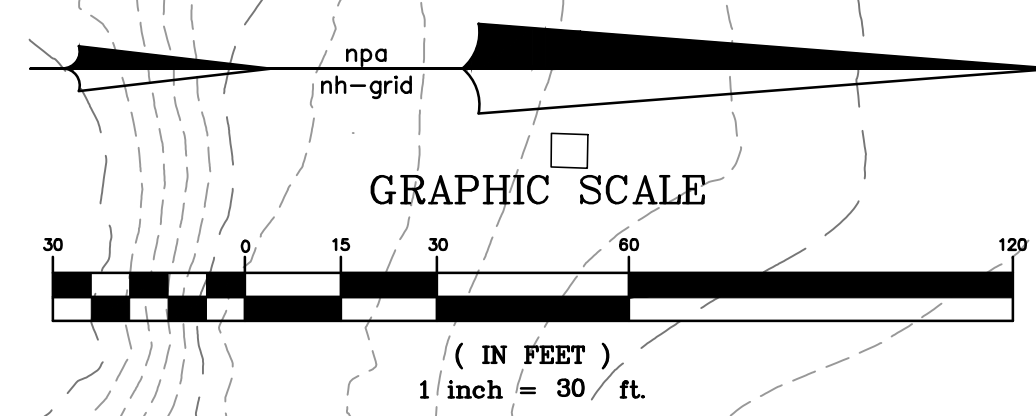
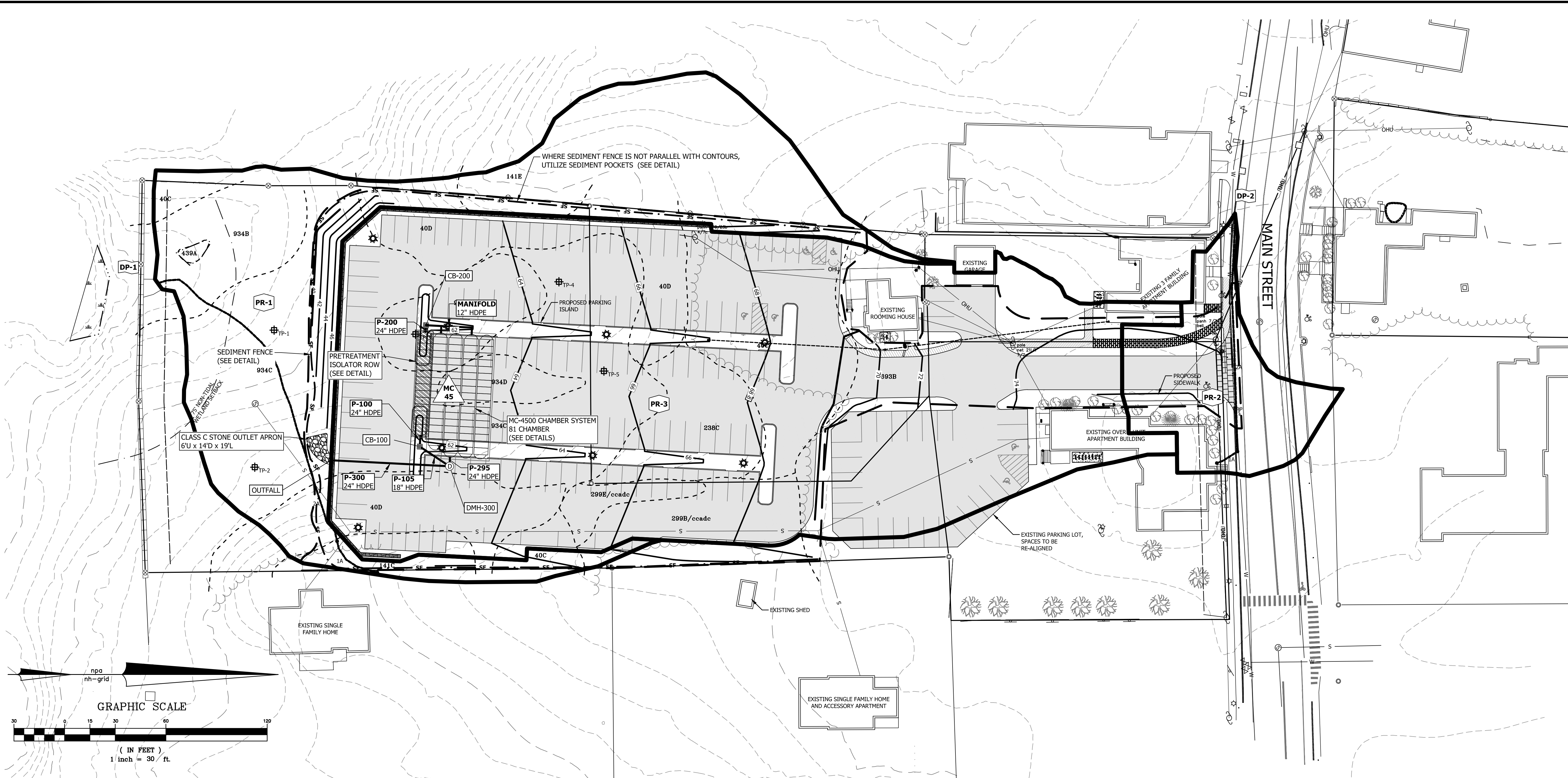

LEGEND

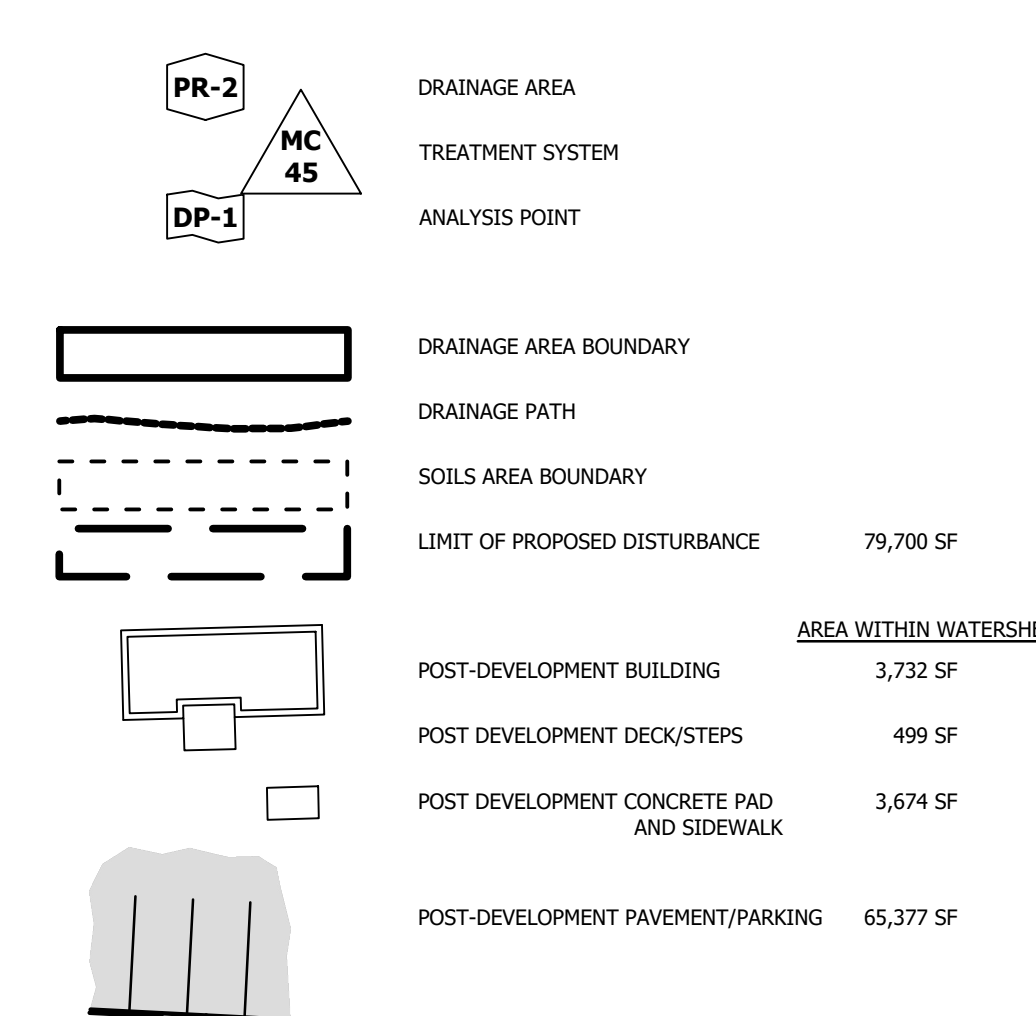

PR-1	TOTAL AREA:	37,822 SF
	IMPERVIOUS COVER:	0.28%
	TIME OF CONCENTRATION:	6.0* MIN
PR-2	TOTAL AREA:	9,503 SF
	IMPERVIOUS COVER:	71.13%
	TIME OF CONCENTRATION:	6.0* MIN
PR-3	TOTAL AREA:	82,224 SF
	IMPERVIOUS COVER:	80.78%
	TIME OF CONCENTRATION:	6.0* MIN

*CALCULATION METHOD MINIMAL TIME

PIPE NUMBER	START STRUCT	END STRUCT	SIZE / MATERIAL	LENGTH	SLOPE	INVERT IN	INVERT OUT
MANIFOLD	CB-200	MANIFOLD	12" HDPE	27.250	0.00%	56.47	56.47
P-100	CB-100	MC-IN-E	24" HDPE	6.580	1.00%	53.76	53.69
P-105	CB-100	DMH-300	18" HDPE	21.099	-2.00%	58.50	58.92
P-200	CB-200	MC-IN-W	24" HDPE	4.020	1.00%	53.73	53.69
P-295	MC-OUT	DMH-300	24" HDPE	5.250	1.00%	53.69	53.64
P-300	DMH-300	OUTFALL	24" HDPE	70.167	7.27%	53.60	48.50

STRUCTURE ID	DETAILS:	PIPES IN:	PIPE OUT
CB-100	RIM: 61.80 INV OUT: 53.76 INV OUT: 58.50		P-100, 24" HDPE P-105, 18" HDPE
CB-200	RIM: 61.80 INV OUT: 53.73 INV OUT: 56.47		P-200, 24" HDPE MANIFOLD, 12" HDPE
DMH-300	RIM: 62.79 INV IN: 53.64 INV IN: 58.92 INV OUT: 53.60	P-295, 24" HDPE P-105, 18" HDPE	P-300, 24" HDPE
MANIFOLD	INV IN: 56.47	MANIFOLD, 12" HDPE	
MC-IN-E	INV IN: 53.69	P-100, 24" HDPE	
MC-IN-W	INV IN: 53.69	P-200, 24" HDPE	
MC-OUT	INV OUT: 53.69		P-295, 24" HDPE
OUTFALL	INV IN: 48.50	P-300, 24" HDPE	

NO.	REVISIONS	DATE	INT.

SEAL
 DATE: 9/26/18
 SCALE: 1"=50'
 DESIGNED BY:
 DRAWN BY:
 APPROVED BY:
 DWG FILE: 20601 CONCEPT 008.dwg

POST-DEVELOPMENT DRAINAGE
 prepared for
TOOMERFS, LLC
 TAX MAP 5, LOTS 1-9 AND 1-10
 19 MAIN ST AND 21 MAIN ST DURHAM, NH

MJS ENGINEERING, P.C.
 CIVIL • STRUCTURAL • ENVIRONMENTAL
 5 HALLAM ST., SUITE 309
 DURHAM, NH 03824
 PHONE: (603) 659-6979, FAX: (603) 659-6627
 E-MAIL: MJS@MJE-ENGINEERING.COM

JOB: 18-041
POST